

ANTIGUA & BARBUDA

RENEWABLE ENERGY ROADMAP



© IRENA 2021

Unless otherwise stated, material in this publication may be freely used, shared, copied, reproduced, printed and/or stored, provided that appropriate acknowledgement is given of IRENA as the source and copyright holder. Material in this publication that is attributed to third parties may be subject to separate terms of use and restrictions, and appropriate permissions from these third parties may need to be secured before any use of such material.

ISBN 978-92-9260-332-8

CITATION: IRENA (2021), Antigua and Barbuda: Renewable energy roadmap, International Renewable Energy Agency, Abu Dhabi.

About IRENA

The International Renewable Energy Agency (IRENA) is an intergovernmental organisation that supports countries in their transition to a sustainable energy future and serves as the principal platform for international co-operation, a centre of excellence, and a repository of policy, technology, resource and financial knowledge on renewable energy. IRENA promotes the widespread adoption and sustainable use of all forms of renewable energy, including bioenergy, geothermal, hydropower, ocean, solar and wind energy, in the pursuit of sustainable development, energy access, energy security and low-carbon economic growth and prosperity. www.irena.org

Acknowledgements

The roadmap has been developed at the request of the Government of Antigua and Barbuda by the International Renewable Energy Agency (IRENA). This report has been made possible by funding from the government of Denmark.

This report benefited from the reviews and comments of numerous experts, including Diann Black-Layne, Ezra Christopher, Melissa Le Blanc (Ministry of Health, Wellness and the Environment), and by Simon Benmarraze, Paula Nardone, Paul Komor and Arieta Gonelevu Rakai (IRENA).

This work was done under supervision of Roland Roesch and Dolf Gielen.

Available for download: www.irena.org/publications

For further information or to provide feedback: publications@irena.org

Roadmap Development Team

This report was authored by Aakarshan Vaid and Emanuele Taibi (IRENA).

Disclaimer

This publication and the material herein are provided “as is”. All reasonable precautions have been taken by IRENA to verify the reliability of the material in this publication. However, neither IRENA nor any of its officials, agents, data or other third-party content providers provides a warranty of any kind, either expressed or implied, and they accept no responsibility or liability for any consequence of use of the publication or material herein.

The information contained herein does not necessarily represent the views of all Members of IRENA, nor is it an endorsement of any project, product or service provider. The designations employed and the presentation of material herein do not imply the expression of any opinion on the part of IRENA concerning the legal status of any region, country, territory, city or area or of its authorities, or concerning the delimitation of frontiers or boundaries.

FOREWORD



Hon. Sir Molwyn M. Joseph

*Minister of Health, Wellness & The Environment
Antigua and Barbuda*

Antigua and Barbuda is a small island state with no known indigenous fossil resources for energy supply; the country imports 100% of petroleum products to meet its energy demands. This dependence on fossil fuels exposes our nation to external shocks and the volatility of the petroleum fuel market. Rising energy costs have impacted communities, households and businesses. The nation's vulnerability and exposure to risk necessitates the transformation of its energy system to better adapt to the impacts of climate change.

The Government of Antigua and Barbuda, led by Prime Minister Hon. Gaston Browne, has made a commitment to contribute to keeping global temperature rise well below two degrees Celsius. The Government has made a written commitment to carbon neutrality by 2050, with the aim to not only contribute to emission reductions but more importantly to develop a robust national energy

system that is based on the utilisation of abundant natural energy resources such as solar and wind.

The Government chose to partner with the International Renewable Energy Agency (IRENA) to understand how to set and achieve ambitious climate and energy goals. Working along with our local team, IRENA has provided this report with technical, financial and socially feasible pathways for Antigua and Barbuda to utilise our abundant natural energy resources.

On behalf of my Government and the People of Antigua and Barbuda, I want to thank IRENA for the invaluable technical support provided to Antigua and Barbuda with the production of the Renewable Energy Roadmap, and our national team of professionals for their contribution towards this report. We look forward to continued collaboration with IRENA and extend the warmest regards to the staff as we continue our work together.

CONTENTS

FIGURES	6
TABLES	8
BOXES	9
ABBREVIATIONS.....	9
EXECUTIVE SUMMARY	10
1. INTRODUCTION TO THE ANTIGUA AND BARBUDA ROADMAP	14
1.1 Roadmap objective	14
1.2 Roadmap analysis overview.....	14
2. SCENARIOS.....	17
3. KEY ASSUMPTIONS.....	20
3.1 Demand analysis.....	20
3.2 Power sector assumptions	21
3.3 General techno-economic assumptions	25
3.4 Transport sector assumptions.....	26
4. RESULTS	29
4.1 Current power system	31
4.2 Existing plans as of 2020	33
4.3 Optimal system	35
4.4 Optimal system plus EVs	38

4.5	100% RE (no hydrogen)	40
4.6	100% RE (with hydrogen)	42
4.7	100% RE (with hydrogen plus EVs)	47
5.	BARBUDA	49
5.1	Background	49
5.2	Results	50
6.	POLICY RECOMMENDATIONS AND CONCLUSIONS	53
6.1	Recommendations	53
6.2	Conclusions	58
	REFERENCES	60
	ANNEX	61

FIGURES

Figure ES 1: Roadmap overview - renewable energy share and cost of electricity in different scenarios	12
Figure 1: Roadmap analysis flow chart	15
Figure 2: Monthly electricity generation for 2019	20
Figure 3: 2019 seasonal load profile	21
Figure 4: HOMER schematic for the 100% RE scenario inclusive of hydrogen and EVs.....	22
Figure 5: EV deployment pathways	28
Figure 6: Roadmap (levelised cost of electricity vs. renewable energy share)	31
Figure 7: Share of generation - 2019 system	32
Figure 8: Installed capacity by technology - 2019 system	32
Figure 9: Hourly dispatch – current power system.....	33
Figure 10: Share of generation – existing plans as of 2020	34
Figure 11: Installed capacity by technology – existing plans as of 2020	34
Figure 12: Hourly dispatch – existing plans as of 2020.....	35
Figure 13: Share of generation – optimal system	36
Figure 14: Installed capacity by technology – optimal system.....	36
Figure 15: Hourly dispatch – optimal system	37
Figure 16: Hourly dispatch – optimal system minus residential demand and rooftop PV generation	38
Figure 17: Share of generation – optimal system plus EVs	39
Figure 18: Installed capacity by technology – optimal system plus EVs	39

Figure 19: Hourly dispatch – optimal system plus EVs.....	40
Figure 20: Share of generation – 100% RE (no hydrogen)	41
Figure 21: Installed capacity by technology – 100% RE (no hydrogen)	41
Figure 22: Hourly dispatch – 100% RE (no hydrogen).....	42
Figure 23: Share of generation – 100% RE (with hydrogen)	43
Figure 24: Installed capacity by technology – 100% RE (with hydrogen)	43
Figure 25: Hourly dispatch – 100% RE (with hydrogen)	44
Figure 26: Net present costs by component – optimal scenario	45
Figure 27: Net present costs by component – 100% RE (with hydrogen) scenario	46
Figure 28: Share of generation – 100% RE(with hydrogen plus EVs)	47
Figure 29: Installed capacity by technology – 100% RE (with hydrogen plus EVs)	47
Figure 30: Hourly dispatch – 100% RE (with hydrogen plus EVs).....	48
Figure 31: Share of generation – Barbuda optimal system	51
Figure 32: Installed capacity by technology – Barbuda optimal system	51
Figure 33: Hourly dispatch – Barbuda optimal system	52
Figure 34: Grid modernisation schematic for Hawaii	55
Figure 35: Hawaiian Electric January 2019 Request for Proposals – capacity vs. prices.....	56
Figure 36: Estimated space required for PV at Parham Ridge Wind Farm site.....	62
Figure 37: Estimated space required for PV adjacent to the Bethesda array.....	62

TABLES

Table ES 1: Investment requirements for each scenario.....	12
Table ES 2: EV charger deployment costs	13
Table 1: Scenarios considered for the roadmap.....	18
Table 2: Power plant generation capacity.....	21
Table 3: Renewable energy generation capacity	22
Table 4: Summary of key assumptions	24
Table 5: Current fleet of vehicles, 2020	26
Table 6: Total road vehicles by fuel type, 2020	26
Table 7: Deployed EVs and assumed daily driving demand	27
Table 8: Assumed EV charging characteristics and EV load calculation	27
Table 9: HOMER deferrable load inputs	28
Table 10: Results of the roadmap	30
Table 11: Green Barbuda Study – results overview	49
Table 12: Results of the Barbuda roadmap	50
Table 13: Current power system overall results	61

BOXES

Box 1: How green hydrogen production contributes to achieving a 100% renewable energy share	45
Box 2: Successful procurement of solar PV and storage in islands – the Hawaii example	54

ABBREVIATIONS

APUA	Antigua Public Utilities Authority	MW	Megawatt
BTM	Behind the meter	MWh	Megawatt-hour
EPC	Engineering, procurement and construction	NDC	Nationally Determined Contribution
EV	Electric vehicle	NPC	Net present cost
GWh	Gigawatt-hour	O&M	Operation and maintenance
IPP	Independent power producer	RE	Renewable energy
IRENA	International Renewable Energy Agency	SUV	Sport utility vehicle
kW	Kilowatt	PPA	Power purchase agreement
kWh	Kilowatt-hour	PV	Photovoltaic
LCOE	Levelised cost of electricity	USD	United States dollar

EXECUTIVE SUMMARY

In 2019, to support the revision process for the Nationally Determined Contributions (NDCs) elaborated under the Paris Agreement, the Government of Antigua and Barbuda requested assistance from the International Renewable Energy Agency (IRENA) to evaluate potential pathways to achieve a 100% renewable energy share by 2030 in both the power and transport sectors. The renewable energy roadmap will support the NDC revision process by looking into least-cost, high-impact pathways for fully decarbonising Antigua and Barbuda's power and transport sectors by 2030 and 2040 respectively.

This roadmap charts the way forward for decarbonising Antigua and Barbuda's power and transport sectors within the targeted time frames. It looks in detail at the power sector and outlines the path to a resilient, decarbonised, least-cost power system, which can be leveraged to decarbonise road transport through electromobility. To achieve the ambitious target proposed by the Government of Antigua and Barbuda, several renewable energy technologies have been analysed. The current power system of the country is widely dominated by conventional fossil fuel generation. Hence, multiple renewable energy options were explored. These include utility-scale solar photovoltaics (PV), distributed solar PV (including PV for the residential sector), utility-scale wind and green hydrogen production. Furthermore, electric vehicles (EVs) were considered for achieving a 100% renewable energy share in the transport sector by 2040.

It must be noted however, that in order to implement the findings of the roadmap, several technical studies would be required. These include: load flow, frequency

and voltage stability, required grid investments and identification of specific projects in precise sites for solar, wind, storage and hydrogen. IRENA conducted a grid integration study in 2016 for Antigua and Barbuda as part of an initiative to analyse the impact of increasing penetration of renewable energy into different island network systems (IRENA, 2015). This existing grid integration study lays the foundation for the aforementioned studies necessary for deploying further renewable energy in Antigua and Barbuda.

The optimisation and analysis of the roadmap was performed with HOMER Pro software, an optimisation tool used to design and technically and financially evaluate options for off-grid and on-grid power systems for remote, stand-alone and distributed generation applications. The current power system of Antigua and Barbuda was used to calibrate the model in HOMER, and subsequently various scenarios were considered to provide the Government with the least-cost pathway for a 100% renewable energy power system by 2030. The study has considered the following five main scenarios:

1. Optimal system¹
2. Optimal system + EVs
3. 100% RE (no hydrogen)
4. 100% RE (with hydrogen)²
5. 100% RE (with hydrogen + EVs)

Figure ES 1 shows the overall results of the renewable energy share and levelised cost of electricity obtained through the optimisation analysis for the various scenarios considered in the roadmap.

1 Least-cost based on net present cost. This is considering solar, wind, and storage, and not considering hydrogen.

2 Includes hydrogen electrolyser, storage and fuel cell for power-to-hydrogen and hydrogen-to-power.

Figure ES 1: Roadmap overview – renewable energy share and cost of electricity in different scenarios

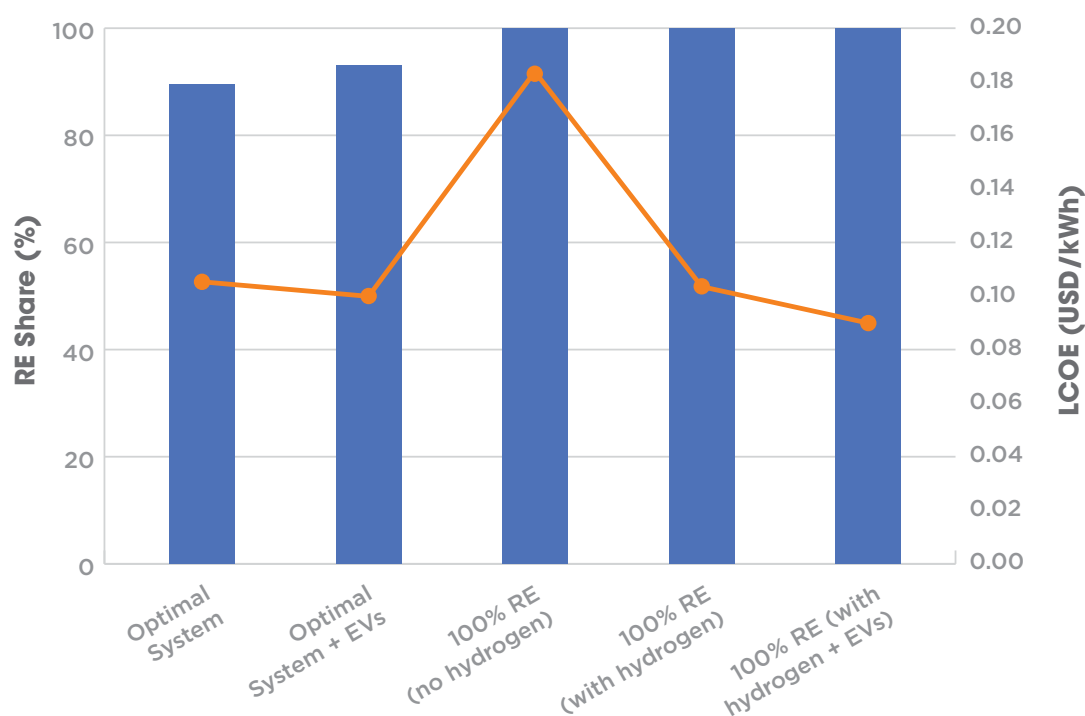

The current power system of Antigua and Barbuda is highly dominated by fossil fuel generation, with only a 3.55% renewable energy share. The results of the optimisation have shown that by increasing the renewable energy capacity based on the current plans of the Government in place as of 2020, Antigua and Barbuda will increase its renewable energy share to around 9% in the next few years. The figure, however, shows that the optimal system would increase the share of renewables for Antigua and Barbuda from the current 3.55% to a potential 90%. For the remaining 10%, the roadmap explored three specific 100% scenarios, namely, 100% RE (no hydrogen), 100% RE (with hydrogen) and 100% RE (with hydrogen plus EVs). By 2040, full deployment of electric vehicles to further increase the renewable energy share in the transport sector

can be achieved cost-efficiently. For the last scenario, the levelised cost of electricity (LCOE) decreases to USD 0.09 per kilowatt-hour (kWh) and is the cheapest option from the five scenarios considered.

Table ES 1 shows the overall investment requirements for each scenario analysed in the roadmap.

The results show that with the optimal system scenario, the Government of Antigua and Barbuda would need to potentially invest an initial capital cost of USD 388 million. When deploying electric vehicles together with the optimal system, the initial investment will increase to USD 498 million due to the additional battery storage required. The results also show that the scenario that would require the highest upfront

Table ES 1: Investment requirements for each scenario

MODEL/SCENARIO	OPTIMAL SYSTEM	OPTIMAL SYSTEM + EVs	100% RE (NO HYDROGEN)	100% RE (WITH HYDROGEN)	100% RE (WITH HYDROGEN + EVs)
Initial capital cost (million USD)	388	498	783	403	440

investment (USD 783 million) is the 100% RE scenario without green hydrogen production. The reason for such a large initial capital cost is the significant amount of storage, solar PV and wind turbines required to achieve the 100% target without investing in hydrogen.

When green hydrogen production is added to the system, the initial capital cost decreases to USD 403 million, while with hydrogen plus EVs it reaches USD 440 million. It is important to note that hydrogen is produced exclusively for use in power generation, to replace the remaining oil products. Once hydrogen production is considered, it replaces part of the battery storage, as hydrogen is de facto being stored for the long term to be used in power generation when solar and wind generation is low for multiple days. Although hydrogen is a very inefficient³ way to store electricity, especially compared to batteries, its storage in large volumes plays a significant role in contributing to system adequacy.

In all EV scenarios, the assumption from the Government is that all cars and other road vehicles will be 100% battery electric vehicles by 2040, increasing gradually from near-zero in 2020. This allows decarbonisation of road transport, without any hydrogen being used outside of the power sector. It is important to note that the initial investment estimated for the scenarios, shown in Table ES 1, inclusive of EVs, does not include the cost of the EVs and the charging infrastructure. Table ES 2 shows the estimate for the total EV charger deployment costs for both private and public charging. The total deployment cost for all the EV charging infrastructure would be USD 75 million, out of which USD 43 million would be paid by the private customers who purchase the EVs for home installation, and the remaining USD 32 million is part of public infrastructure.

Table ES 2: EV charger deployment costs

EV CHARGER INVESTMENT COST (MILLION USD)	
Private home charging	Public charging
43	32

Without putting in place the necessary policies and regulations, however, the implementation of the scenarios identified is unlikely to be achieved. The following recommendations should be considered by the Department of Environment for successful accomplishment of the proposed target:

1. Follow international best practices for procurement
2. Move forward with a renewable independent power producer (IPP)
3. Make residential solar PV beneficial for the system.

A key recommendation for the Government of Antigua and Barbuda is to follow international best practices for engineering, procurement and construction (EPC) of the proposed renewable solutions. This will bring down the overall costs of the project, in addition to making projects more attractive to international EPC companies, developers and suppliers. Partnership between the international suppliers and local companies will also be essential in helping the local economy and creating jobs.

Another recommendation outlined from the roadmap is for new power purchase agreements (PPAs) with independent power producers, to exclusively purchase renewable electricity rather than generic electricity or electricity based on oil products. It is also recommended for the Government of Antigua and Barbuda to explore ways to make residential solar PV beneficial for the system and not problematic. This can be done by ensuring that technologies complementary to solar PV are installed, and by creating incentive tariffs for charging batteries during peak hours rather than selling electricity to the grid. Furthermore, time-of-use tariffs should be designed to incentivise customers to use more electricity during times when demand is low.

In conclusion, implementing the recommendations outlined in the roadmap will put Antigua and Barbuda on a pathway shifting from a power system widely dominated by fossil fuel generation towards one with higher shares of renewable energy.

³ Hydrogen efficiency is less than 45%, compared to the more than 90% efficiency of batteries.

1. INTRODUCTION TO THE ANTIGUA AND BARBUDA ROADMAP

1.1 Roadmap objective

Located between the Caribbean Sea and the Atlantic Ocean, Antigua and Barbuda is an island nation consisting of two land masses with a total area of 443 square kilometres. Apart from the two inhabited islands that are separated by a distance of 43 kilometres, Antigua and Barbuda also includes many smaller islands that are uninhabited (CIA, 2015). According to the World Bank, in 2018 Antigua and Barbuda had a population of 96 286 inhabitants.

The Government of Antigua and Barbuda has proposed a target of achieving 100% of its electricity generation from renewable energy sources by 2030. This target was proposed during the revision process for the Nationally Determined Contributions (NDCs) elaborated under the Paris Agreement. As the energy sector of the country is currently highly dependent on fossil fuels, a transition to 100% renewable power will reduce emissions by more than 90% and will create the necessary environment for 100% adoption of electric vehicles (EVs) in the transport sector.

To this extent, the Government of Antigua and Barbuda requested the International Renewable Energy Agency (IRENA) to undertake a study to outline a roadmap for transitioning to 100% renewable energy in both the power and transport sectors, to inform the revision of its NDCs. The roadmap will serve as a least-cost pathway for the power and passenger car sectors, which will feed into Antigua and Barbuda's NDC submission for 2021.

The main objective of this study is to assist Antigua and Barbuda in developing a roadmap to transition its energy and transport sectors to 100% renewable energy by 2030 and 2040 respectively. The roadmap will look in detail

at the energy sector as a whole and identify a resilient least-cost pathway for the development of Antigua and Barbuda's power sector until 2030. Furthermore, it will explore renewable energy options for the transport sector such as EVs by 2040.

1.2 Roadmap analysis overview

IRENA has been actively supporting islands with their energy transition to a renewable energy future, through the development of detailed renewable energy roadmaps (IRENA, 2017a). Such roadmaps provide clear pathways including technical, economic and policy aspects that can allow large-scale adoption of renewable energy.

From the various techno-economic modelling tools available in the market, HOMER Pro was used to develop the roadmap for both the electricity and transport sectors. HOMER is an optimisation tool used to design and technically and financially evaluate options for off-grid and on-grid power systems for remote, stand-alone and distributed generation applications. It allows the user to consider numerous types of technology options to account for energy resource availability and other variables. The model's ultimate goal is that of simulating and providing the user with the most inexpensive and viable solution for all possible combinations according to the initial system inputs. Depending on the inputs, HOMER can simulate hundreds or even thousands of viable systems.

This chapter summarises the analysis methods and the various renewable energy sources and technologies considered for the study. Figure 1 provides an overview of the roadmap methodology and models used.

Figure 1: Roadmap analysis flow chart

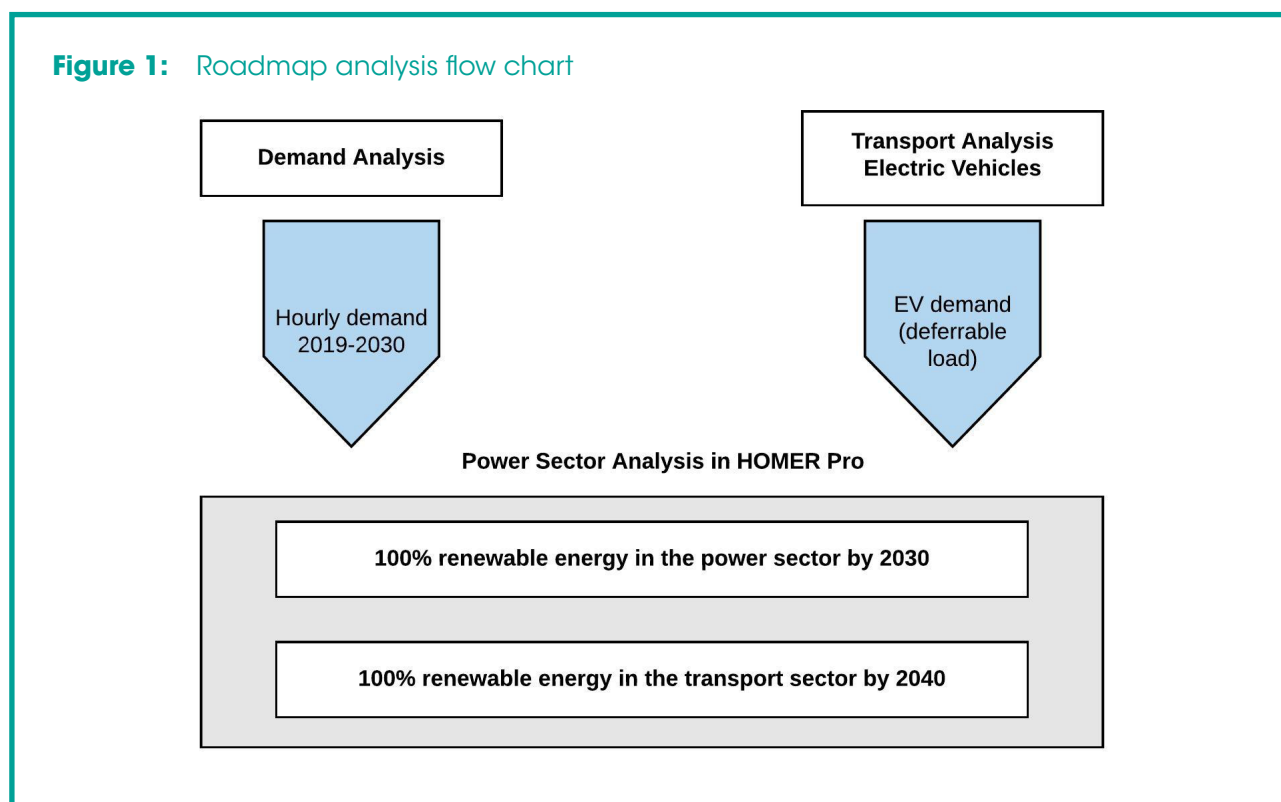

The roadmap study consisted of analysing the deployment of renewable energy options for Antigua and Barbuda in the following two sectors/applications:

1. Electricity generation
2. Road transport

The following sections describe the details of both applications including the various options considered for each sector to achieve the 100% renewable energy target.

Electricity generation

The analysis for Antigua and Barbuda's electricity sector was done to perform a detailed optimisation of the current situation as well as for 2030. The first step was to prepare a baseline demand forecast and then to add the planned renewable energy systems for 2030 including additional suggested technologies to achieve 100% renewable electricity. The baseline forecast was prepared using data on the existing generators provided by the Antigua Public Utilities Authority (APUA). The baseline demand forecast is important as it is used for determining the required generation resources.

Section 3.1 (Demand analysis) describes in more depth the methodology for developing the baseline demand.

In order to achieve 100% renewable electricity generation, various renewable energy technologies will need to be considered for future deployment. The power sector of Antigua and Barbuda is highly dependent on conventional fossil fuels and import of heavy fuel oil, hence various renewable energy options must be considered to achieve the ambitious target of 100%. From the several technologies available, the ones considered for this study include the following:

- **Distributed solar PV:** including rooftop PV for the residential sector
- **Utility-scale solar PV:** ground-mounted PV arrays
- **Utility-scale wind:** onshore wind farms
- **Hydrogen:** production of green hydrogen from solar and wind.

Together with the deployment of the above-mentioned renewable energy technologies, battery storage systems

will be essential to achieve 100% renewable energy in both sectors. Batteries provide many services to increase the reliability of the electricity system and support renewable energy integration. Furthermore, stored electricity can meet peak demand without the need to commit additional generation units, it can support the electricity system's voltage and frequency, and it can meet demand when renewable energy is not available.

Road transport

For the transport sector of Antigua and Barbuda, the analysis was also done using HOMER Pro by adding the electric vehicle load as a deferrable load (that is, an

electrical load that requires a certain amount of energy within a given time period). The EV load was added to the power sector analysis and was performed together.

Antigua and Barbuda's transport sector is dominated by fossil fuels, mainly gasoline and diesel-powered vehicles, and only a few EVs are currently available in the country. Hence, the analysis for the potential of renewable energy in the transport sector focused on the following topic and added to the electricity sector analysis discussed above:

- **EVs powered by renewable energy:** the potential reduction in fuel imports for transport and the increased level of renewable electricity generation required to power EVs.



2. SCENARIOS

The roadmap analysis performed for Antigua and Barbuda's power system evaluated several scenarios based on the information provided by the Ministry of Health, Wellness and the Environment. In order to simulate the scenarios in HOMER Pro, the model had to first be calibrated. The calibration was done by simulating the current power system of Antigua and Barbuda.

The current power system model served as the basis for the other scenarios considered in the study. As the name suggests, this model represents the current power system of the island, which is highly dominated by generation from heavy fuel oil together with a minimal percentage of renewable generation, solely from solar PV. The reason for considering this was to show the existing power system of Antigua and Barbuda and to estimate the current renewable share.

To model the current power system in HOMER Pro software, the baseline electricity demand for 2019, estimated from the hourly load data of 2012, was used. The demand analysis and calculations performed to estimate the baseline load are discussed in more detail in chapter 3. The power generation for the current power system comes mostly from 3 main power plants, which use a total of 14 generators running on heavy fuel oil. The three power plants are the APC, Blackpine and Wadadli power plants, with the latter decommissioned on 15 September 2020.

The calibration model considered all the generators currently present in the three power plants in Antigua and Barbuda, which are three 14.4 megawatt (MW), one 17.1 MW, two 8.6 MW, two 6.6 MW and six 6 MW generators. It also considered the current renewable energy capacity, which includes 7 MW of centralised solar PV and 2 MW of distributed solar PV. It was assumed that for the current solar PV systems there

are no battery storage system and converter. Once all these inputs were added to the model, an optimisation of capacity and dispatch was performed using HOMER.

After preparing the calibration model, a secondary model was prepared representing the existing plans of the Government as of 2020. This model was selected to show what share of renewable energy can be achieved based on the existing plans of the Ministry of Health, Wellness and the Environment, and how far along this share would be to reaching the 100% target. The electricity demand for this model remained the same as 2019 with 375 gigawatt-hours (GWh) per year. According to the plans of the Government, 5 MW of distributed solar PV will be added to the existing 9 MW of solar PV capacity, in addition to 4.13 MW of wind power (15 turbines of 275 kilowatt (kW) capacity each). In this model, the six 6 MW generators of the Wadadli power plant were removed as the plant was decommissioned. The remaining heavy fuel oil generators of the Blackpine and APC power plants remained the same. The storage and battery inverter were optimised using the HOMER optimiser.

Once the calibration model and the plans of the Government were simulated in HOMER, the various scenarios considered in this study were prepared. The roadmap for Antigua and Barbuda analysed the following five scenarios:

- Optimal system
- Optimal system + EVs
- 100% RE (no hydrogen)
- 100% RE (with hydrogen)
- 100% RE (with hydrogen + EVs)

Table 1 shows the various scenarios along with the different technologies considered for the study.

Table 1: Scenarios considered for the roadmap

SCENARIOS	TECHNOLOGY CONSIDERED
Optimal system	PV + wind + diesel
Optimal system + EVs	PV + wind + diesel + EVs
100% RE (no hydrogen)	PV + wind
100% RE (with hydrogen)	PV + wind + hydrogen
100% RE (hydrogen + EVs)	PV + wind + hydrogen + EVs

Optimal system

The first scenario analysed in this study was the optimal system scenario. This scenario considers the current plans of the Government along with additional renewable energy capacity based on land availability and extra capacity based on the HOMER optimiser, which minimises the system's net present cost. The reason for selecting this scenario was to show the maximum renewable energy share that can be achieved based on the plans and based on land availability for installing further renewable capacity. The electricity demand for this scenario remained the same as the previous ones at 375 GWh/year. As with the existing plans model, the generators of the Wadadli power plant were not considered in this scenario.

Based on the information provided by the Government of Antigua and Barbuda, the average household consumes just over 3 000 kilowatt-hours per year (kWh/year) or 8.25 kWh/day. Based on this, it was estimated that a 3 kW solar PV system with battery storage would be added on the rooftop of each household. Hence, with an assumption of 30 000 households in Antigua and Barbuda, this scenario evaluated a total capacity of 90 MW for the residential sector. A secondary model was also analysed showing the optimal system without the residential load and is discussed more in detail in section 4.3.

Furthermore, based on the land availability provided by the Government, with a total of around 80 hectares, the model considered a future ground-mounted PV capacity of 100 MW. For the wind power capacity, the scenario considered adding another 13.5 MW to the original 4.13 MW. The HOMER optimiser also was used to evaluate any additional wind power capacity that would

make it possible to increase the renewable energy share. The optimiser was further used for sizing the battery storage system and the converter for the various renewable energy systems.

Optimal system + EVs

The second scenario analysed in this study was the optimal plus EVs scenario. This scenario was considered to show how the renewable energy share, electricity demand and levelised cost of electricity (LCOE) of the optimal system scenario would be affected by adding electric vehicles. Hence, a deferrable load was added to the optimal scenario to represent the EV demand. A deferrable load can be defined as an electrical load that requires a certain amount of energy within a given time period. The deferrable load was calculated based on the data received from the Antigua and Barbuda Transport Board and is discussed in detail in chapter 3. The HOMER optimiser was used in this scenario to optimise the ideal additional capacity of renewables needed to meet the increased electricity demand due to the EV load. The optimiser was also used to size the appropriate converter and battery storage needed.

100% RE (no hydrogen)

The third scenario considered was the 100% RE without hydrogen scenario. As the name suggests, this scenario represents a 100% renewable energy power system but without considering green hydrogen production. This scenario was selected to show that there is a possibility to achieve the ambitious target set by the Government of Antigua and Barbuda with just solar and wind energy.

In addition to the original plans of the Government (including 100 MW of ground-mounted systems and 90 MW of rooftop systems), an additional capacity of PV and wind was estimated using the HOMER optimiser. The optimiser also estimated the ideal battery storage capacity required for such a system.

100% RE (with hydrogen)

The fourth scenario considered for the roadmap analysis was the 100% RE scenario with hydrogen. This scenario estimated the ideal renewable energy capacity needed to achieve the target of the Government to cover all the electricity demand from solely renewables by 2030. In order to achieve the 100% share of renewable energy, any fossil fuel generation had to be removed from the model, hence this scenario did not consider any of the current power plants that run on heavy fuel oil. Together with the solar and wind capacity of the previous scenario, additional capacity for both solar and wind was estimated using the HOMER optimiser. Furthermore, in order to achieve the 100% share, green hydrogen production from renewables was considered. In HOMER, a hydrogen tank, an electrolyser and a fuel cell were added and optimally sized using the optimiser. Adding these components increased the electricity

demand to 562 GWh/year. As for all the other scenarios, the ideal size for the storage and converter were also optimised.

100% RE (hydrogen + EVs)

The last scenario considered in the analysis was the 100% RE scenario with hydrogen plus EVs. This scenario was considered in order to show how much additional renewable energy capacity will be needed to cover the demand for hydrogen as well as the demand for charging electric vehicles. For this scenario, the demand for the EVs was added as a deferrable load in HOMER Pro. This load was added together with the current electric demand of 375 GWh/year, hence increasing the demand and concurrently the renewable energy capacity. Similar to the previous scenario, a hydrogen tank, electrolyser and fuel cell were added into HOMER to perform an optimisation for their ideal size. The HOMER optimiser was also used to estimate the size of the storage and converter, and any additional PV and wind capacity needed to meet the new electric demand.

The results of the various optimisations performed on HOMER Pro for both the power and transport sectors are discussed in more detail in chapter 4.



3. KEY ASSUMPTIONS

This chapter discusses the various assumptions that were considered when performing the HOMER modelling. It covers the key assumptions considered when estimating the baseline electricity demand for 2019 and the assumptions for the main components and the project economics in the HOMER model. It also encompasses the assumptions considered for the power sector, and for the transport sector when estimating the EV deferrable load.

3.1 Demand analysis

The 2019 annual load profile for Antigua and Barbuda was estimated using the hourly load demand for 2012. The following section details the data provided by APUA on the electricity generation and the methodology used to estimate the hourly load for 2019, which served as the baseline year for the roadmap analysis.

2019 baseline electricity demand

To estimate the load for Antigua and Barbuda, data were needed on the energy production from the existing generators. APUA provided IRENA with data on the generation of each power plant for four consecutive years: 2016, 2017, 2018 and 2019. However, the data provided for 2019 (the most recent year) were monthly values and not hourly. Hence, hourly values for electricity generation in 2019 had to be estimated using hourly values of a previous year. Data on energy produced for 2012 were the most detailed ones available for IRENA to estimate hourly values for 2019. Each hourly value for 2012 was first converted into a percentage representing the share of the total monthly demand; subsequently, the hourly demand for 2019 was estimated using this percentage. Figure 2 shows the monthly and total energy production/load for 2019.

Figure 2: Monthly electricity generation for 2019

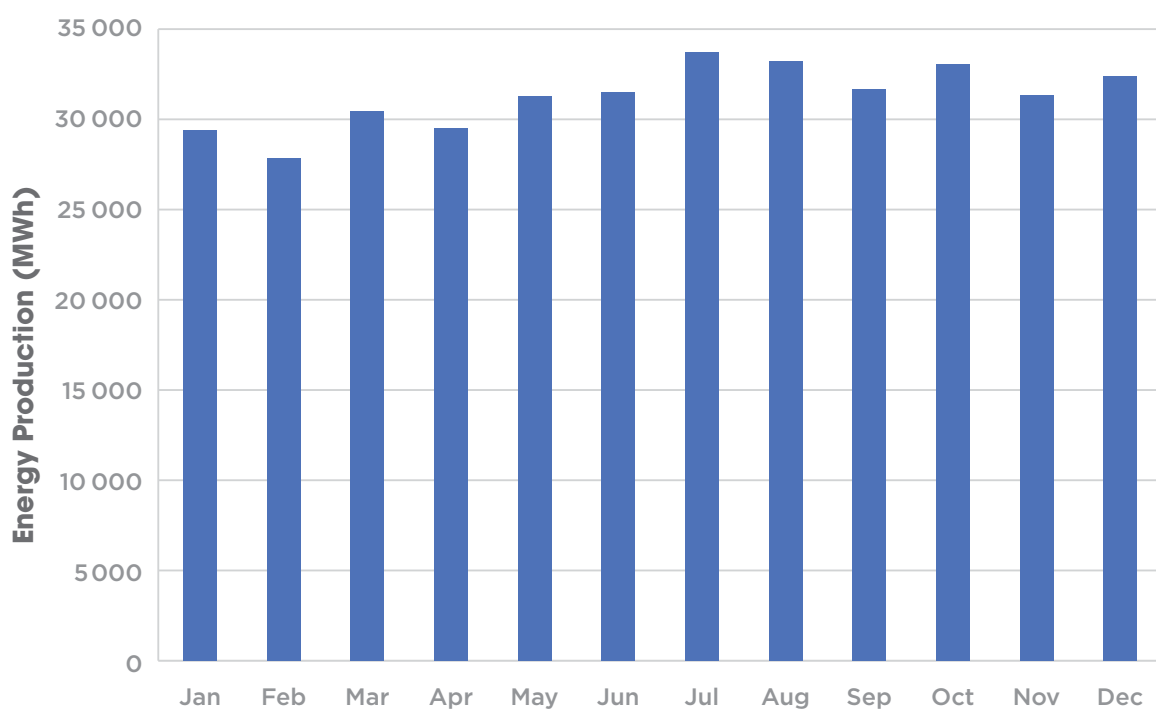
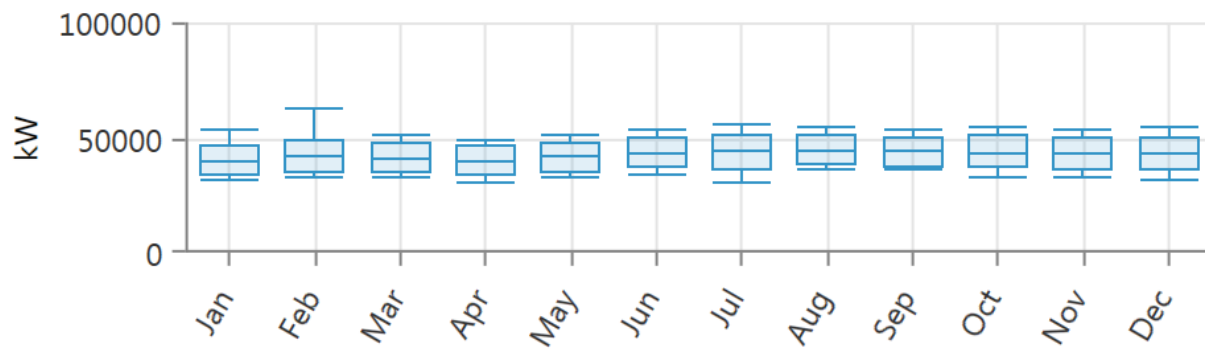

Figure 3: 2019 seasonal load profile



From the data provided on the energy produced by each generator of each power plant for 2019, the total energy produced or load for 2019 was estimated as 375 332 megawatt-hours (MWh). Once the hourly values for the electricity generation in 2019 were estimated, the data were inputted into HOMER Pro in order to create the demand profile that would serve as the baseline electricity demand. Figure 3 shows the 2019 seasonal load profile created for the analysis.

The seasonal load profile is a plot representing the monthly minimums, maximums and averages. For every month, the top line corresponds to that particular month's overall maximum load, while the bottom line represents the overall minimum load for that month. The top of the blue box is the average of the daily maximums

of all of the days in the month, and the bottom of the box is the average daily minimum. The middle line is the overall average for the whole month (HOMER, n.d.).

3.2 Power sector assumptions

Antigua and Barbuda's power sector relies heavily on conventional fossil fuel generation to supply electricity. Currently, the country has a total of three main power plants consisting of heavy fuel oil generators of various capacities. The APC Power Plant is the largest on the island with three generators of 14.4 MW and one of 17.1 MW. The Blackpine Power Plant consists of a total of four generators, two of them with 6.6 MW of capacity, and the other two with 8.6 MW. The third power plant,

Table 2: Power plant generation capacity

POWER PLANT	NO. OF GENERATORS	FUEL	CAPACITY (MW)	TOTAL CAPACITY (MW)
APC	3	Heavy fuel oil	14.4	60.3
	1	Heavy fuel oil	17.1	
BLACKPINE	2	Heavy fuel oil	6.6	30.4
	2	Heavy fuel oil	8.6	
WADADLI	6	Heavy fuel oil	6	36
TOTAL				126.7

which was decommissioned on 15 September 2020, is the Wadadli Power Plant, with six generators of 6 MW each all powered by heavy fuel oil. Table 2 details the generation capacity for each power plant presently in Antigua and Barbuda.

Together with the high fossil fuel generation, Antigua and Barbuda also has some renewable energy generation capacity. The current renewable energy capacity consists of a 3 MW solar PV system installed at the airport, the 4 MW Bethesda solar PV array and 2 MW of distributed solar PV. The currently installed renewable energy capacity in Antigua and Barbuda is shown in Table 3.

According to the information provided by Antigua and Barbuda’s Ministry of Health, Wellness and the Environment, the Government is planning to deploy further renewable energy in the near future including 5 MW of additional distributed solar PV and 4.13 MW of wind power (15 turbines of 275 kW each). Moreover, based on studies conducted by the Government, around 40 hectares of land is estimated to be available at the Parham Ridge wind farm site and 40 hectares adjacent to the 4 MW Bethesda solar system for possible future deployment of renewables. These two sites can be used for future solar PV installations, and hence the roadmap analysis considered the possibility of a future ground-mounted PV system of around 100 MW capacity.

For the residential sector, the roadmap analysis considered a total of 30 000 households with the average household electrical consumption of 8.25 kWh/day or just above 3 000 kWh/year. Based on this, it was estimated that a 3 kW PV system would be added on the rooftop of each household thereby contributing to a total capacity for the future residential sector of 90 MW. For future scenarios, the roadmap also considered the possibility of installing

an additional 13.5 MW of wind turbines, based on a technical feasibility study conducted by the Department of Environment of Antigua and Barbuda.

To perform the detailed modelling of Antigua and Barbuda’s power sector in HOMER Pro, several key assumptions had to be made and were used for each scenario modelled. Assumptions had to be made not only for the main components such as the solar PV panels, wind turbines, converter, battery and diesel generators, but also for the economics of the project. These key assumptions are discussed in more detail below.

Figure 4 shows a schematic diagram from HOMER of the 100% RE power system inclusive of hydrogen and EVs, of Antigua and Barbuda.

Table 3: Renewable energy generation capacity

	RENEWABLE ENERGY TECHNOLOGY	CAPACITY (MW)
AIRPORT	Solar PV	3
BETHESDA	Solar PV	4
DISTRIBUTED	Solar PV	2

Figure 4: HOMER schematic for the 100% RE scenario inclusive of hydrogen and EVs

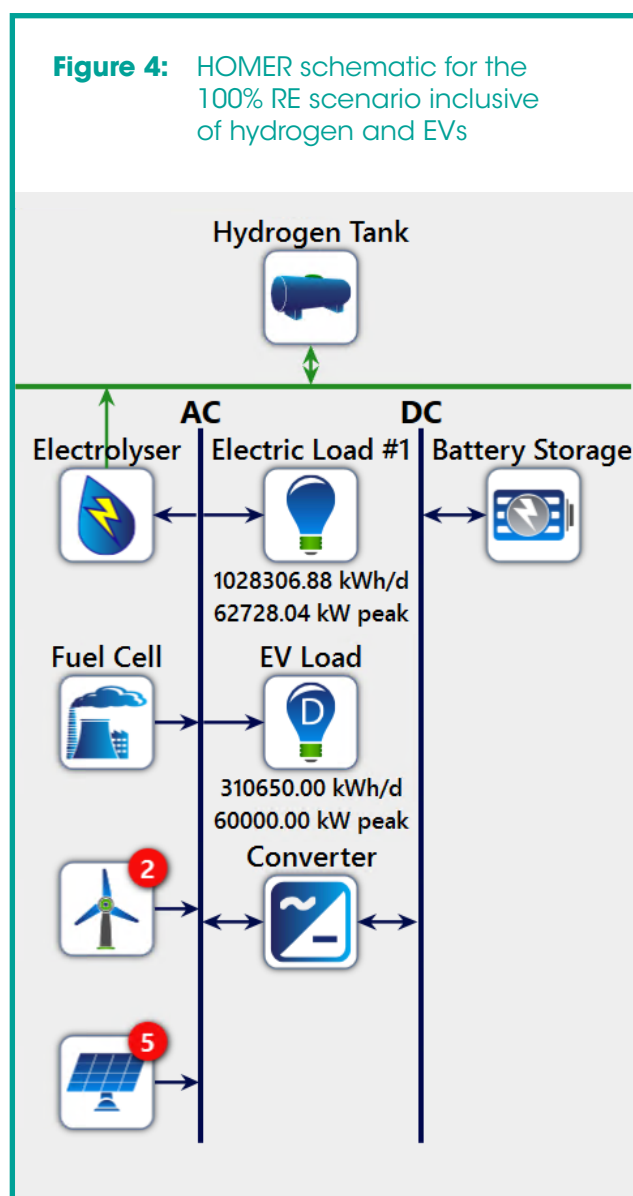

Solar PV

For all the scenarios considered, various assumptions were made on the capital cost, operating cost, replacement cost and lifetime of the solar PV panels. The assumptions were based on the latest IRENA cost analysis (IRENA, 2020a) and on further cost reduction expected over the next ten years. The capital cost, which is the total installed cost of the solar PV array at the beginning of the project, was assumed to be zero for the current existing PV capacity in Antigua and Barbuda, as the system has already been installed. For future planned projects, the capital cost was assumed to be USD 600/kW for ground-mounted PV and USD 1000/kW for rooftop PV. The operation and maintenance (O&M) cost for the current centralised PV was assumed to be USD 4/kW per year, while for the current distributed PV capacity it was assumed to be zero. For future PV systems, both ground-mounted and residential, the O&M was assumed to be USD 10/kW per year. For all PV systems considered in this study, the lifetime of the panels was considered to be 25 years and the derating factor to be 80%.

Wind turbine

For future wind capacity in Antigua and Barbuda, the 275 kW Vergnet wind turbine with a hub height of 55 metres was selected in HOMER. The capital and replacement costs for one turbine were assumed to be USD 411 675, while the O&M cost for one turbine was assumed to be USD 4 116.75/year. The estimated lifetime for all the wind turbines considered in the roadmap was assumed to be 20 years.

Battery storage

For the battery storage system considered in all future scenarios, a generic lithium-ion battery was selected in HOMER. The cost assumptions were based on IRENA's latest report on electricity storage and renewables (IRENA, 2017b). The capital and replacement costs were assumed to be USD 250/kWh and USD 150/kWh respectively. The battery was also assumed to have an initial state of charge of 100% and a minimum state of charge of 20%, with a degradation limit of 30% before replacement.

Battery inverter/rectifier

The various costs for the battery inverter/rectifier were also based on IRENA's latest cost analysis. The capital cost for the converter was inputted into HOMER as USD 105/kW. For this component, the replacement cost was assumed to be the same as the capital cost. Other assumptions include the relative capacity of 100%, a rectifier and inverter efficiency of 95% and a total lifetime of 15 years.

Diesel genset

Based on the information received from the Government and APUA on the current generators of Antigua and Barbuda, each specific generator of the three power plants in the country was represented in HOMER. This was done by preparing detailed fuel curves based on the data received. With regard to the cost assumptions of the generators, the capital cost was assumed to be zero since the generators are already running. The replacement cost was assumed to be USD 500/kW and the O&M to be USD 0.03/hour of operation. Since all the generators run on heavy fuel oil, the fuel price was assumed to be around USD 0.50/litre. The lifetime of the generators was inputted as 15 000 hours with a minimum load ratio of 25%.

Electrolyser

To model green hydrogen production in HOMER, an electrolyser was selected. Assumptions made for the electrolyser include a capital cost of USD 450/kW, a replacement cost of USD 250/kW and an O&M cost of USD 25/kW/year. The costs are based on an expected rapid reduction (IRENA, 2020b) compared to today's prices (IRENA, 2019a) over the next ten years. Other assumptions include a minimum load ratio of 0%, an efficiency of 70% and a lifetime of 15 years.

Hydrogen tank

One of the main components needed when modelling green hydrogen production is the hydrogen tank to store the hydrogen produced from renewable energy. For every 1000 kilograms, the capital cost of the tank was assumed to be USD 100, while the replacement and O&M costs were inputted as USD 100/year and USD 1/year respectively. The hydrogen tank was assumed to have a total lifetime of around 25 years.

Fuel cell

The third component needed for simulating green hydrogen production in HOMER was the hydrogen fuel cell. With a capital cost of USD 600, a replacement cost of USD 400 and an O&M cost of USD 0.01/hour of operation, the fuel cell was assumed to have a lifetime of around 50 000 hours.

Table 4: Summary of key assumptions

COMPONENTS	ASSUMPTION (UNIT)	VALUE
SOLAR PV (INCLUDING INVERTER)	Capital cost (USD/kW)	600 (ground-mounted)
		1 000 (rooftop)
	Replacement cost (USD/kW)	500 (ground-mounted)
		600 (rooftop)
	O&M cost (USD/kW/year)	10
Lifetime (years)	25	
WIND TURBINE (275 KW PER UNIT)	Capital cost (USD/unit)	411 675
	Replacement cost (USD/unit)	411 675
	O&M cost (USD/unit/year)	4 116.75
	Lifetime (years)	20
BATTERY STORAGE	Capital cost (USD/kWh)	250
	Replacement cost (USD/kWh)	150
	O&M cost (USD/kWh/year)	0
BATTERY INVERTER/ CHARGER	Capital cost (USD/kW)	105
	Replacement cost (USD/kW)	105
	O&M cost (USD/kW/year)	0
	Lifetime (years)	15

DIESEL GENSET	Capital cost (USD/kW)	0
	Replacement cost (USD/kW)	500
	O&M cost (USD/kW/operating hour)	0.03
	Fuel price (USD/litre)	0.50
	Lifetime (hours)	15 000
ELECTROLYSER	Capital cost (USD/kW)	450
	Replacement cost (USD/kW)	250
	O&M cost (USD/kW/year)	25
	Lifetime (years)	15
HYDROGEN TANK	Capital cost (USD/tonne)	100
	Replacement cost (USD/tonne)	100
	O&M cost (USD/tonne/year)	1
	Lifetime (years)	25
FUEL CELL	Capital cost (USD/kW)	600
	Replacement cost (USD/kW)	400
	O&M cost (USD/kW/operating hour)	0.01
	Lifetime (hours)	50 000

3.3 General techno-economic assumptions

Together with the main components in the HOMER model, assumptions were also made for the economic and financial parameters. These assumptions were essential in order to achieve more detailed and precise results for the financial part of the project. The key assumptions include a nominal discount rate of 7%, an expected inflation rate of 1.9%, a real discount rate of 5%, a value of lost load of USD 20/kWh and a project lifetime of 25 years. The system fixed capital cost and system fixed O&M cost were both assumed to be zero.

With regard to the project constraints, further assumptions had to be made to run the models. The maximum annual capacity shortage was inputted as 1%, while the minimum

renewable fraction was set to be 0%. In terms of operating reserves, the load in current time-step was assumed to be 10%, and the annual peak load to be 0%. The solar power output was set as 20% and the wind power output as 30%.

Once all of the above assumptions were inputted into HOMER, an optimisation was performed for the various scenarios considered in this analysis. Chapter 4 covers in more detail the different results obtained for each scenario. The results include hourly dispatch results for the whole year. In the report, for readability and exemplification, only the chart for two specific days of the year is plotted, while full results with hourly data for the full year are provided to the Government of Antigua and Barbuda for reference. All annual data in the report are not based on the two specific days in the charts but on hourly data for the full year.

The days selected were the first two days of the year, the 1st and 2nd of January. These two days were selected because the month of January typically has constant and steady winds as opposed to irregular winds during the dry season, making it possible to visualise some of the higher solar and wind penetration days, as well as the quite large differences between the two days in terms of wind generation. Any other day can be explored in the full spreadsheet provided together with this report.

3.4 Transport sector assumptions

As mentioned previously, Antigua and Barbuda's transport sector is dominated by fossil fuels. The data provided by the Antigua and Barbuda Transport Board show that at present, there are 54 891 road transport vehicles in the country, with more than 97% of them fuelled by gasoline and the remaining 2.7% running on diesel. Table 5 illustrates the current fleet of vehicles in Antigua and Barbuda as of 2020.

The data in Table 5 show that 58% of the total vehicles in the country are automobiles. This is followed by sport utility vehicles (SUVs), representing 32% of the total, vans (2.6%), buses (2%) and pickup trucks (1.4%). Table 6 provides a breakdown by fuel type of the road transport vehicles currently present in Antigua and Barbuda. The table reflects both the oil dependence and preference for gasoline as the main fuel for powering vehicles.

Given the relatively small land area of Antigua and Barbuda, with just 440 square kilometres, electric vehicles represent an attractive option for meeting a large share of the transport demand with renewable energy. It must be noted, however, that for EVs to support an increased share of renewables in the national energy balance, it is crucial for them to be charged by electricity generated from renewable sources.

The roadmap analysis looked into the possibility of replacing all the current fleet of vehicles with EVs by 2040. For modelling this scenario in HOMER, the electric load for the EVs had to be inputted as a deferrable load. However, in order to run this scenario in HOMER, the electric load for charging the EVs had to first be estimated. Therefore, it was necessary to make several assumptions related to both the distance being driven by the vehicles in Antigua and Barbuda, and also the charging characteristics of the EVs being deployed.

Table 5: Current fleet of vehicles, 2020

VEHICLE TYPE	TOTAL VEHICLES	% OF TOTAL VEHICLES
ATVs	124	< 1
Buggies	85	< 1
Buses	1 094	2
Cars	31 826	58
Carts	19	< 1
Hearses	8	< 1
Jeeps	162	< 1
Limos	6	< 1
Motorcycles	694	1.3
Pickup trucks	772	1.4
Scooters	171	< 1
SUVs	17 390	32
Trucks	464	< 1
Vans	1 441	2.6
Wagons	635	1.2
Total vehicles	54 891	

Note: ATV = all-terrain vehicle; SUV = sport utility vehicle

Table 6: Total road vehicles by fuel type, 2020

FUEL TYPE	TOTAL VEHICLES
Gasoline	53 422
Diesel	1 469

Due to the high preference for gasoline as the principal fuel for most vehicles in Antigua and Barbuda, the calculations were performed based on only vehicles running on gasoline. To estimate the total deferrable load, the vehicles were first aggregated based on their type. For example, cars, wagons and vans were considered to be similar, as well as pickup trucks together with SUVs and jeeps. Large buses were those considered to have a capacity of more than 15 persons, while mini-buses were buses considered to have a seating capacity of between 7 to 15 passengers. Scooters and motorcycles were calculated separately. A daily driving demand of 25 kilometres was assumed for all EVs deployed except the buses and mini-buses, which were assumed to have a daily demand of 200 kilometres. Table 7 shows the EVs considered per vehicle type along with the assumed daily driving demand.

With regard to the EV charging characteristics, it was assumed that the cars, wagons and vans had a nominal battery capacity of 40 kWh/vehicle, while the pickup trucks, SUVs and jeeps had a battery capacity of 60 kWh/vehicle, and the scooters and motorcycles had a capacity of 5 kWh/vehicle. For the buses and mini-buses, the assumed battery capacity per vehicle was 240 kWh and 100 kWh respectively. These assumptions were based on the newest EV models currently available in the market for each type. The EV efficiency was also assumed based on the datasheets of the currently available EVs. The assumed EV characteristics along with the EV load calculation are shown in Table 8.

Table 7: Deployed EVs and assumed daily driving demand

VEHICLE TYPE	FUEL TYPE	NUMBER OF ELECTRIC VEHICLES	km/DAY
Cars + wagons + vans	Electricity	34 000	25
Pickup trucks + SUVs + jeeps	Electricity	18 000	25
Large buses	Electricity	100	200
Scooters + motorcycles	Electricity	1 000	25
Mini-buses (7-15 passengers)	Electricity	1 000	200

Note: SUV = sport utility vehicle

Table 8: Assumed EV charging characteristics and EV load calculation

VEHICLE TYPE	BATTERY NOMINAL CAPACITY (kWh/VEHICLE)	EV EFFICIENCY (kWh/km)	DAILY DEMAND PER EV (kWh)	INTERNAL CHARGER CAPACITY (kW/VEHICLE)	kWh/DAY
Cars + wagons + vans	40	0.164	4.1	3.6	139 400
Pickup trucks + SUVs + jeeps	60	0.2	5.0	3.6	90 000
Large buses	240	1	200.0	36	20 000
Scooters + motorcycles	5	0.05	1.3	1.8	1 250
Mini-buses (7-15 passengers)	100	0.3	60.0	10.8	60 000

Note: SUV = sport utility vehicle

To estimate the total EV deferrable load to input in HOMER, a contemporaneity factor of 0.30 was used. The total battery nominal capacity for all EVs was estimated by multiplying the assumed battery capacity per type of vehicle by the total number of vehicles per type. The total sum was then multiplied by the contemporaneity factor to give a total estimated nominal capacity of 770 700 kWh. The total internal charger capacity was similarly estimated by multiplying each assumed capacity by the number of vehicles and then the total sum by the contemporaneity factor. The total internal charger capacity was estimated to be around 61 020 kW. Finally, the deferrable load was calculated by multiplying the number of vehicles by the assumed daily driving demand and the EV efficiency. The total estimated deferrable load was 310 650 kWh/day.

The total values used as input for the deferrable load in HOMER are shown in Table 9.

Based on the assumptions on electric vehicles outlined above, and assuming that there are 51 490 vehicles in 2020 and the number of vehicles in the future does not grow further, expanding the EV share of new vehicle registrations from 0% in 2020 to 100% of new registrations in 2030 leads to 100% of the car stock being EVs by 2037. If the stock number does not change, this is 51 490 EVs on the road by 2037. Figure 5 shows how the market share for new registrations of EVs will gradually shift to 100% by 2030 following a logistic substitution. Assuming an average vehicle life of 10.6 years⁴ and a stock of 51 490 vehicles in 2020 (without any change in the future), 100% new EV sales in 2030 means 100% of the stock in 2037.

Table 9: HOMER deferrable load inputs

SCALED ANNUAL AVERAGE (kWh/DAY)	STORAGE CAPACITY (kWh)	PEAK LOAD (kW)
310 650	770 700	61 020

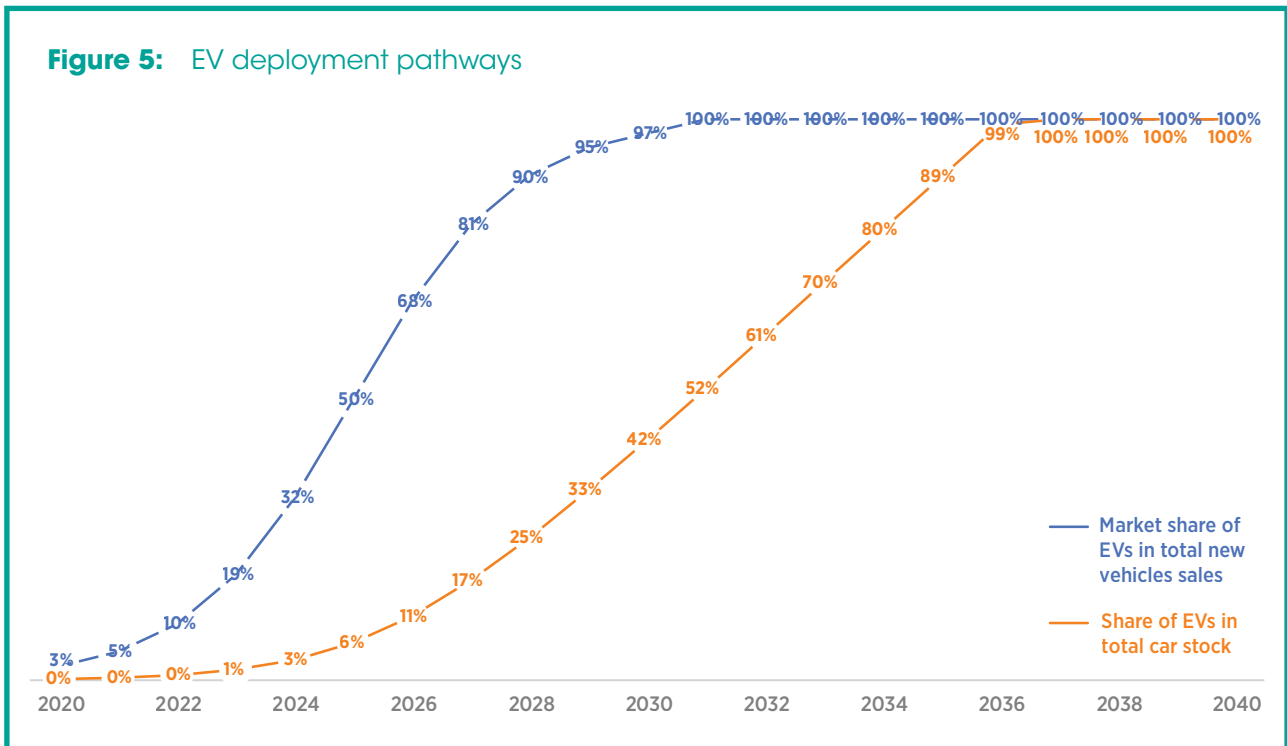

⁴ Note that with a vehicle lifespan of 20 years, this will lead to 100% of the car stock being electric vehicles by 2047.

4. RESULTS

This chapter elaborates the main results obtained from the various HOMER models for each scenario considered. The results and outcomes from the modelling are discussed in detail and key figures and charts are provided, showing how the Government of Antigua and Barbuda can achieve the ambitious target set of 100% renewable energy generation in the power sector by 2030 and in the transport sector by 2040.

The five scenarios considered in this study were each modelled in HOMER to show what share of electricity currently comes from renewables and how much capacity is further needed to achieve the ambitious target set by the Government of Antigua and Barbuda of 100% renewable energy by 2030. The main results of the analysis conducted in HOMER for each scenario are shown in Table 10.

Table 10 shows how Antigua and Barbuda can achieve the target set by the Government by increasing the country's renewable energy generation and decreasing its high consumption of fossil fuels. The results from the calibration model have confirmed the high dominance of fossil fuel generation and the minimal renewable energy capacity. The results also show, however, that the target of 100% renewable energy generation can be achieved by decommissioning the generators and increasing the installed renewable energy capacity.

The optimal scenario has shown that it is possible for Antigua and Barbuda to drastically increase its renewable energy share by deploying more solar PV, wind and storage. The optimal plus EVs scenario showed that by adding electric vehicles to the optimal system, Antigua and Barbuda can reach even closer to the set target. The roadmap also looked into the possibility of achieving a

100% renewable energy share with only solar PV and wind. The results show that this is indeed possible, but a very large battery storage system capacity will be needed to accomplish this. The roadmap also explored the production of green hydrogen together with solar PV and wind to achieve a 100% renewable energy share. Finally, the optimisation included a scenario with EV deployment together with green hydrogen production to reach 100% renewable energy shares in both the power and transport sectors. The results of the HOMER modelling for each specific scenario are discussed in more detail below.

Figure 6 provides an overview of the roadmap, showing how the different scenarios explored in this analysis vary in terms of the LCOE and renewable energy share.

The figure shows how, with the current power system of Antigua and Barbuda, the Government is still distant from accomplishing the target set. However, the figure also shows how with the current plans of the Government, the LCOE decreases from USD 0.15/kWh to USD 0.14/kWh, and simultaneously the renewable energy share increases from 3.55% to almost 9%. A more significant increase in the renewable energy share is noticed when looking at the optimal system scenario. In this specific scenario, the share of renewables increases to almost 90%, with the LCOE decreasing to USD 0.105/kWh. When electric vehicles are deployed with the optimal scenario, the renewable energy share increases even further, reaching 93.1%. The EVs also allow the LCOE to decrease from the previous USD 0.105/kWh to USD 0.10/kWh.

From the optimal system plus EVs scenario, three options are explored to reach the 100% renewable energy share. The first option is the scenario excluding green hydrogen

Table 10: Results of the roadmap

MODEL/SCENARIO	OPTIMAL SYSTEM	OPTIMAL SYSTEM + EVs	100% RE (NO HYDROGEN)	100% RE (WITH HYDROGEN)	100% RE (WITH HYDROGEN + EVs)
Electricity demand including EVs (GWh/year)	375	489	375	620	722
Excess electricity (GWh/year)	117	100	500	102	62
Rooftop PV (MW)	92	92	92	92	92
Ground-mounted PV (MW)	107	107	280	110	122
Total PV (MW)	199	199	372	202	214
Total wind (MW)	58	89	111	101	117
Hydrogen tank (metric tonnes)	0	0	0	500	500
Electrolyser (MW)	0	0	0	75	100
Fuel cell (MW)	0	0	0	40	40
Diesel (kW)	(x3) 14 400 (x2) 8 640 (x2) 6 600 (x1) 17 076	(x3) 14 400 (x2) 8 640 (x2) 6 600 (x1) 17 076	0	0	0
Storage (MWh)	593	828	1 398	164	138
Battery inverter/rectifier (MW)	62	116	196	100	100
Renewable energy share (%)	89.5	93.1	100	100	100
Cost of energy (USD/kWh)	0.105	0.10	0.184	0.104	0.09
Initial capital cost (million USD)	388	498	783	403	440
Net present cost (million USD)	560	692	985	548	603
Operating cost (million USD/year)	12.1	13.6	14.2	10.3	11.5

Figure 6: Roadmap (levelised cost of electricity vs. renewable energy share)

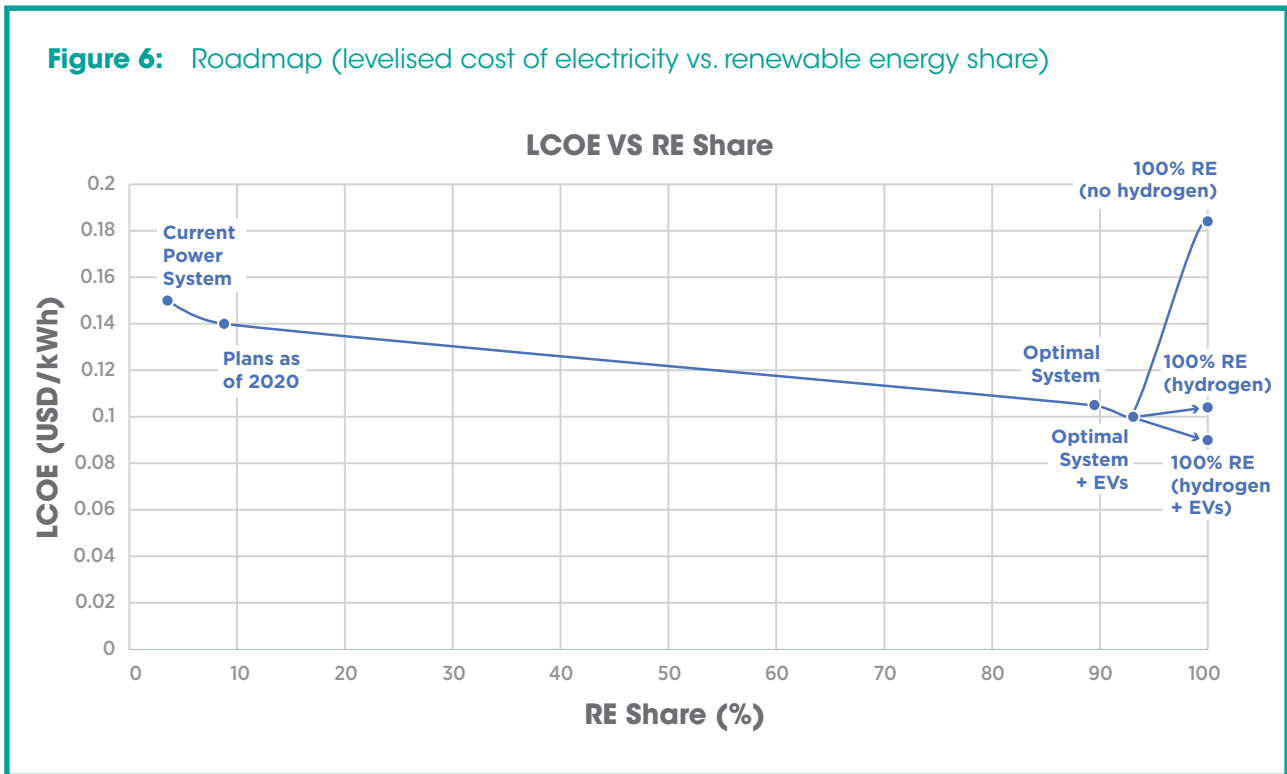

production. The results show that 100% renewable energy is possible by increasing the solar PV, wind and battery storage capacity. However, deploying such a large battery storage system then results in having the highest LCOE among all the scenarios considered. With green hydrogen production and increasing the solar and wind capacity, the LCOE decreases to USD 0.104/kWh. Figure 6 also reveals that the least-cost option for achieving a 100% renewable energy share is the last scenario considered in the analysis, having green hydrogen production and also integrating EVs. If the Government deploys electric vehicles and at the same time also produces green hydrogen for power, this will result in an LCOE of USD 0.09/kWh.

4.1 Current power system

The results of the optimisation performed for the current power system of Antigua and Barbuda have confirmed that today's power system is highly dominated by fossil fuels with merely 3.55% of the electricity share coming from renewables. Hence, there is a lot of potential to increase the share of renewables and concurrently reduce fossil fuel generation. With an electricity demand of 375 GWh/year, the results have shown that there is no

excess electricity. The country currently consumes a total of 65.8 million litres of heavy fuel oil, with average fuel use per day of 180 305 litres and average fuel use per hour of 7 513 litres. The optimisation of the current power system shows high emission values of 197 629 tonnes of carbon dioxide per year.

In terms of economics, the modelling estimates that the LCOE for the current power system is USD 0.15/kWh and that the net present cost is around USD 803 million. The simulation results estimate an operating cost for the current power system of around USD 56.4 million/year.

Figure 7 illustrates the share of generation for the current power system. It shows how much of the total electricity demand is currently being covered by the various generators and existing solar systems. As shown in the chart, around 96% of the current electricity demand of Antigua and Barbuda is being covered by the three power plants. This translates to a total amount of around 362 GWh per year. The results show that 57% of the demand is covered by the country's largest power plant, APC, while Blackpine covers 31% of the load and the recently decommissioned Wadadli power plant was covering 8%. The remaining 3.55%, or 13 GWh per year, of the electricity demand is currently being covered by solar PV.

Figure 7: Share of generation
– 2019 system

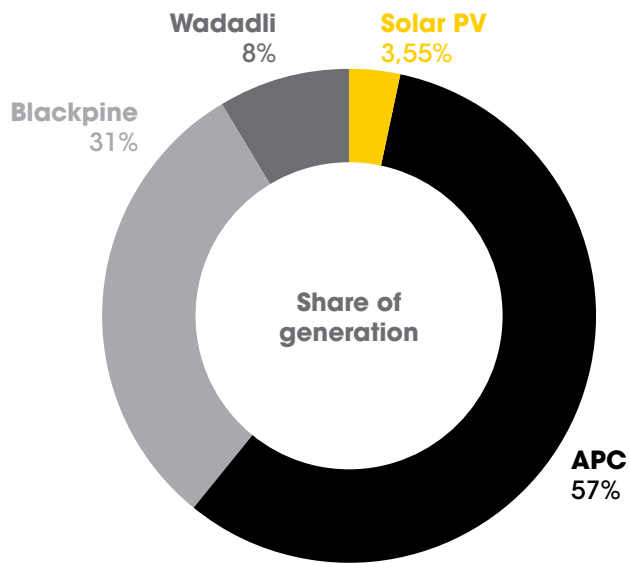

Figure 8: Installed capacity by technology
– 2019 system

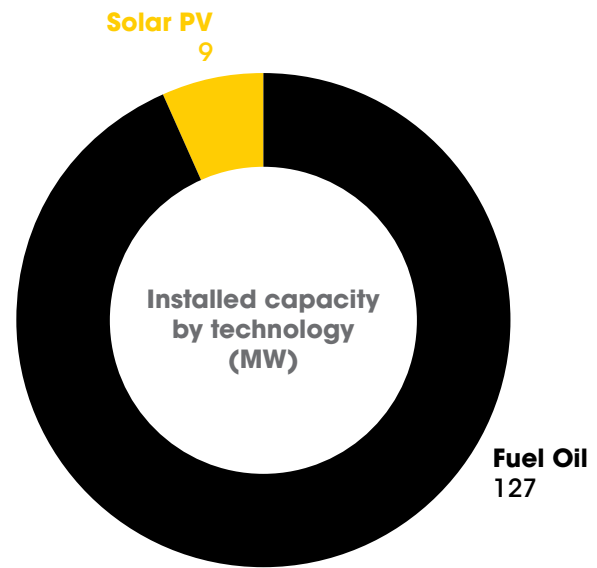

Figure 8 shows the installed capacity by technology for the current power system. Once again, this figure confirms the high dominance of fossil fuel consumption, with a total of 127 MW of heavy fuel oil generation capacity and a mere 9 MW of solar PV capacity.

The hourly dispatch during 1-2 January for the current power system can be observed in Figure 9. The figure shows how the heavy fuel oil generators (black stacked area) cover most of the total load (light-blue line), especially during the early morning and night-time hours of the day. The graph also shows how the solar PV starts to generate electricity during the morning hours on 1 January (7 a.m. to 1 p.m.) and to cover part of the load, but when the sun is no longer available, the generators cover the entire electrical demand. In the

case of 1 January, it can be assumed that the sun was only available during the early hours of the day and hence most of the load was covered by the generators.

For 2 January, it can be seen that there is more solar generation than the previous day, signifying a sunnier day with less clouds. The solar systems currently present in Antigua and Barbuda covered part of the total load on 2 January, from around 6 a.m. to 5 p.m., after which the entire demand was covered by the three power plants. It is important to note that there is no battery storage system currently deployed in Antigua and Barbuda, hence the solar systems can only generate electricity during the day when sunlight is available. This makes it indispensable for the heavy fuel oil generators to cover the entire load during evening hours.

Figure 9: Hourly dispatch – current power system

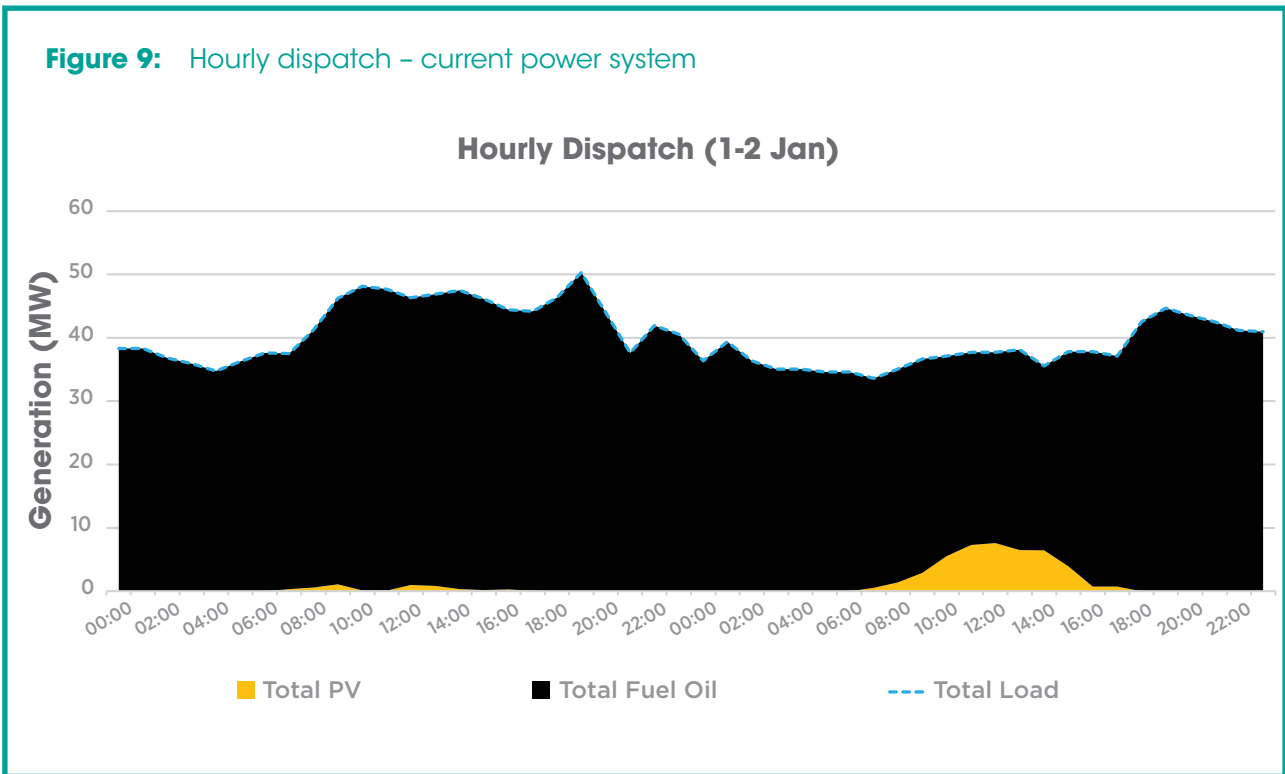

4.2 Existing plans as of 2020

The results of the existing plans as of 2020 modelled into HOMER have showed that according to these Government plans, by decommissioning the Wadadli power plant and by adding the additional wind capacity of 4.13 MW and additional distributed solar capacity of 5 MW, the renewable energy share will increase from 3.55% to around 8.8%. The results show that although the renewable energy share will increase significantly, it is still far from the ambitious target set by the Government of Antigua and Barbuda. Hence, there is still a long way to go to achieve 100% electricity generation exclusively from renewables.

The optimisation has also estimated the ideal size for the battery storage system and the converter to be 15 MWh and 12 MW respectively. Similar to the calibration model, with a total electricity demand of 375 GWh per year, there will be no excess electricity generated. Furthermore, there will be no unmet electric load and no capacity shortage. By increasing the renewable energy capacity and decommissioning the Wadadli power plant and its six 6 MW generators, as per the plans, Antigua and Barbuda can save around 3.6 million litres of heavy fuel oil per year. With a fuel price assumption of

USD 0.5/litre for heavy fuel oil, this translates to annual savings of around USD 1.8 million as opposed to the current power system. The results have shown that the average fuel use per day would decrease to 170 388 litres and the average fuel use per hour to 7 100 litres. This is a significant decrease in heavy fuel oil consumption when compared to the current power system of the country.

When analysing the economics of this model, the LCOE was estimated to be USD 0.14/kWh, hence decreasing slightly from the previous USD 0.15/kWh. The results also showed that deploying additional renewable energy capacity, according to the plans, will result in an initial capital cost of USD 14.1 million and an operating cost of USD 51.5 million/year. The net present cost was estimated to be around USD 747 million. When comparing with the current power system, it can be seen that the deployment of further renewable energy capacity will result in a lower net present cost and a lower operating cost.

The results of implementing more renewable capacity as per the Government’s plans is clearer when observing the share of generation shown in Figure 10. The chart shows how by increasing the renewable capacity and decommissioning Wadadli, a higher proportion of the demand will be covered by renewable energy.

Figure 10: Share of generation
- existing plans as of 2020

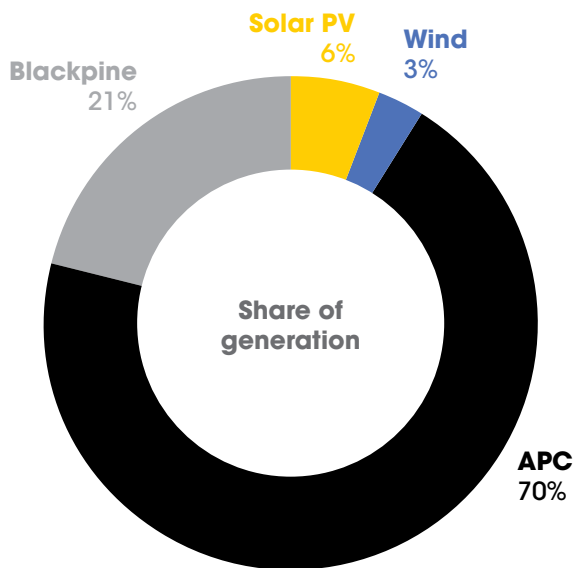
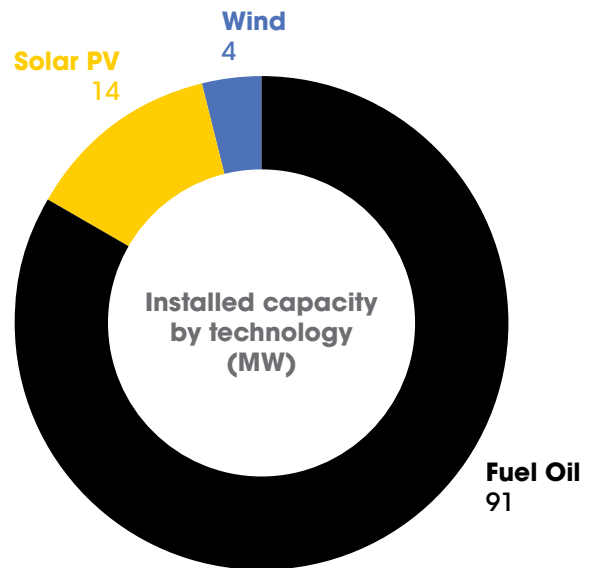

Figure 11: Installed capacity by technology
- existing plans as of 2020



APC, as the largest power plant in Antigua and Barbuda, will still have the largest share of generation with 70% or around 264 GWh. The other power plant, Blackpine, will cover around 20% of the load, and the remaining 9% of the electricity demand will be covered by solar PV (6%) and wind (3%).

The total installed capacity by technology is illustrated in Figure 11. The doughnut chart shows that the total installed capacity of heavy fuel oil generation will decrease to 91 MW from the current power system's 127 MW. Furthermore, by deploying 5 MW of distributed PV, the solar capacity would increase to 14 MW and the wind power capacity would be around 4 MW.

The hourly dispatch curve in Figure 12 illustrates how the various components of the power system would meet the electricity demand. The figure shows the total PV power output, the total wind power output, the total heavy fuel oil generator output, the battery generation, the battery charging and the total load. As observed from the graph, most of the total load (light-blue line) is being served by the heavy fuel oil generators (black stacked area). As opposed to the current power system of Antigua and Barbuda, the heavy fuel oil generators

are covering the whole demand only for a couple of hours during 1-2 January. For the remaining hours of the day, they cover most of the demand, and the rest is covered by renewables. In the current power system, when the solar PV is not generating, the generators cover the entire load. In this scenario, however, from the early morning hours to the later evening hours, wind and solar PV generation partially covers the load.

The reason that the renewable energy technologies are able to cover the load also during night-time hours is thanks to the battery storage and converter. On 1 January, the solar PV only generates electricity from 8 a.m. to 2 p.m., thus signifying that it was a cloudy day with not much sunlight available. The wind turbines, on the other hand, generate electricity almost evenly throughout the whole day. On the next day, it is clear that the solar PV panels generate more electricity than the previous day and contribute significantly in meeting the total load from 8 a.m. to 4 p.m. The wind turbine power output for 2 January was also higher compared to 1 January. The hourly dispatch graph helps show how deploying further renewable energy capacity aids in decreasing fossil fuel consumption and concurrently increases the renewable energy share.

Figure 12: Hourly dispatch – existing plans as of 2020

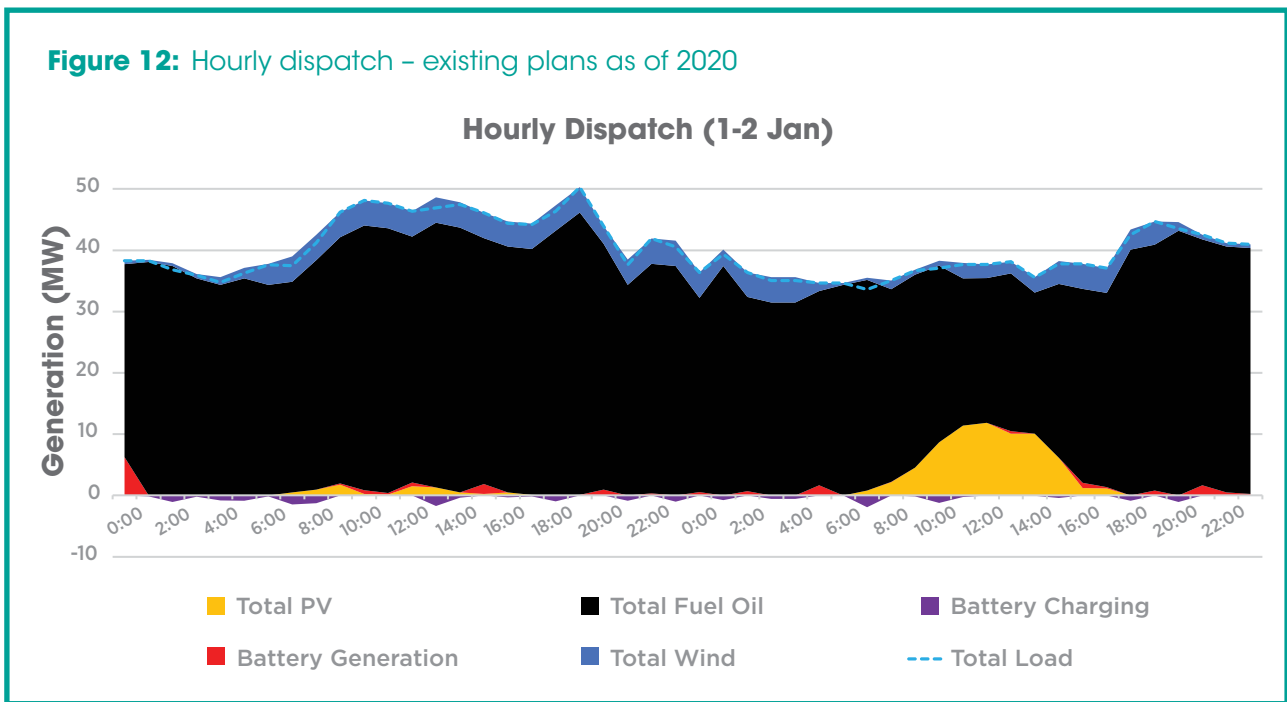

4.3 Optimal system

The first scenario of this study, the optimal system scenario, analysed the current plans of the Government along with additional renewable energy capacity based on land availability and extra capacity based on the HOMER optimiser. The optimal system is the least-cost scenario based on net present cost. It considers solar, wind, and storage, and does not consider hydrogen. The results of the optimisation show that by adding a further 90 MW of rooftop PV, 100 MW of ground-mounted PV, 13.5 MW of additional wind capacity and an extra wind capacity of 40 MW, the renewable energy share will markedly increase to almost 89.5%. The battery inverter and storage were optimised to 62 MW and 593 MWh respectively.

By increasing its renewable energy capacity based on the plans and land availability, the Government of Antigua and Barbuda has the potential of almost reaching its target of 100% renewable energy. With a total load of 375 GWh, the results have shown excess electricity of 117 GWh per year. Moreover, no unmet electric load or capacity shortage was found through the simulation. In terms of fuel savings, the total heavy fuel oil consumed by Antigua and Barbuda in this scenario would be around 7.2 million litres. This is almost nine times smaller than the current heavy fuel oil consumption of 65.8 million litres. The fuel savings would then translate to almost USD 29.3 million saved when compared to the current power system. The average

fuel use per day was estimated to be 19 817 litres and the average fuel use per hour to be 826 litres.

The HOMER optimisation has estimated the initial capital cost for deploying these renewable energy systems to be around USD 388 million and the LCOE to be USD 0.105/kWh. This indicates a clear and significant reduction in the LCOE from the current power system to the optimal system scenario. This confirms that by deploying further renewable energy capacity, also considering the current cost reductions in renewable energy technologies, the project begins to become more economically viable and renewable energy becomes an attractive solution. This scenario has a net present cost of USD 560 million and an operating cost of USD 12.1 million. When comparing these results with the existing plans as of 2020 and the current power system, it becomes clear that the optimal system has lower costs due to the increase in renewable energy capacity.

Figure 13 shows the share of generation for the optimal system scenario and the main components. There is a substantial difference when compared to the current power system's share of generation, with solar PV and wind being the most dominant sources in the optimal system scenario. The largest share of generation comes from solar PV, with 57% or 295 GWh. Wind turbines cover 35% of the total electricity demand, and the remaining load is met by the APC and Blackpine power plants.

Figure 13: Share of generation
- optimal system

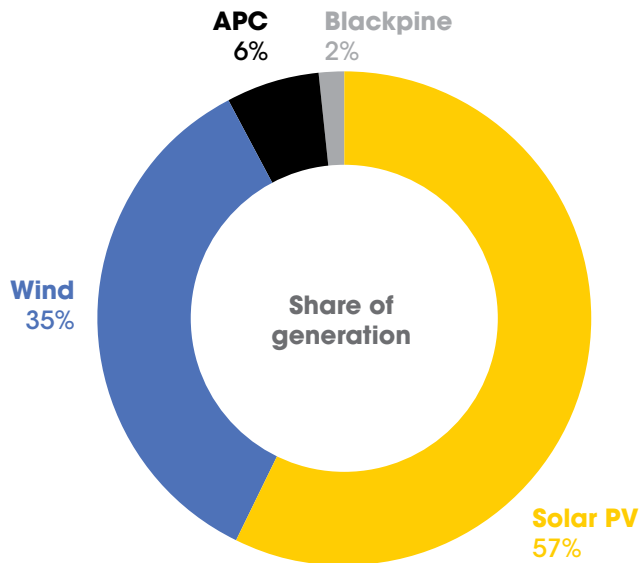
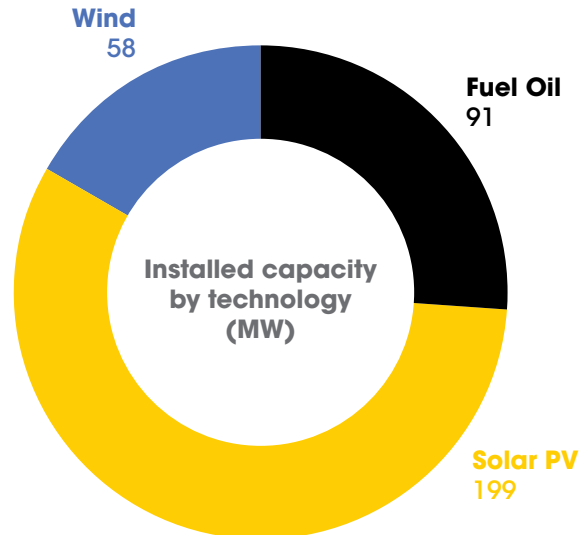

Figure 14: Installed capacity by technology
- optimal system



Note that for this scenario, the Government of Antigua and Barbuda would require only the current generators of the APC power plant in order to support the system. Therefore, with a total of 60.3 MW (although running only occasionally, with a capacity factor of less than 10%), the generators of the Blackpine power plant could be decommissioned, as the remaining load would be covered by renewables. Furthermore, the APC generators could eventually be fuelled with green hydrogen (or biodiesel) in order to reach a 100% renewable energy share. This is explored in the last two scenarios (100% with hydrogen, with and without EVs).

The doughnut chart showing the total installed capacity by technology for the optimal system can be seen in Figure 14. From the chart it can be noted that solar PV is the largest installed capacity with a total of 199 MW. It is then followed by the heavy fuel oil generators with 91 MW and then wind with 58 MW. The reason that the heavy fuel oil installed capacity is greater than the wind turbines is because of the already installed generators at the APC and Blackpine power plants. However, although the generator capacity is larger, the system runs the generators much less than in the current power system,

and most of the total load is served from wind and solar PV, hence resulting in a higher share of generation for wind and solar than for heavy fuel oil.

Note that the ramping capabilities of internal combustion engines are more than enough to cover the net load variability (load minus generation from variable renewable energy sources), and the start-up time is in the order of 30 minutes. Meanwhile, the battery in this scenario has the capacity of running the grid without any diesel generation for over 13 hours.

A clearer understanding of how solar PV and wind meet the electricity demand and thus increase the renewable energy share of Antigua and Barbuda is given by observing the hourly dispatch curve for 1-2 January in Figure 15. The figure clearly shows how solar and wind generate electricity throughout the day, and then the stored energy in the batteries is used to cover the demand throughout the night. During the selected days there was no electricity generation from the heavy fuel oil generators, signifying that the generators were not needed to cover any portion of the total load, as it was entirely met by renewables.

In the early morning hours of 1 January, stored electricity in the batteries from the previous day was used to cover most of the total load. This is evident by observing the red stacked area of the battery generation. A small amount of generation is present from the wind turbines during the early morning hours but is not sufficient to cover the total demand. During the 5 a.m. hour, however, all of the load is covered by the wind turbines, and from around 6 a.m. curtailment is already visible. The excess electricity is being stored in the battery storage system, to be used at a later time when required.

Also notable when looking at the hourly dispatch for 1 January is that the wind turbines generated more electricity than the solar systems, even though the total installed capacity of solar PV exceeds that of wind. The reason for this could be a cloudy day where not much sunlight was available. When observing the hourly dispatch for 2 January, a large peak of solar and wind is noticeable from 8 a.m. to 5 p.m. The peak is the excess electricity generated from both solar PV and the wind turbines. During the last hours of the day on 2 January, the stored electricity from the batteries is used once more to cover most of the total load.

Grid resiliency (optimal system minus residential)

An additional model was simulated together with the optimal system scenario to show the total demand of the grid without the residential solar PV. Therefore, the residential demand was removed from the total demand and HOMER was used to re-optimize the ideal solution. The results of this simulation have shown that the total load for Antigua and Barbuda without the residential load would be around 250 GWh/year. Such a system would have 94 GWh of excess electricity production and no unmet electric load and no capacity shortage. With 109 MW of total solar PV capacity and 45 MW of total wind capacity, the renewable energy share would be 78%. The LCOE was estimated to be USD 0.108/kWh with an initial capital cost of USD 208 million. The net present cost and operating cost were optimized to be USD 382 million and USD 12 million per year respectively.

The hourly dispatch curve for 1-2 January illustrated in Figure 16 shows how the new demand without the residential load is met by the various components. The graph shows how stored electricity in the batteries from

Figure 15: Hourly dispatch – optimal system

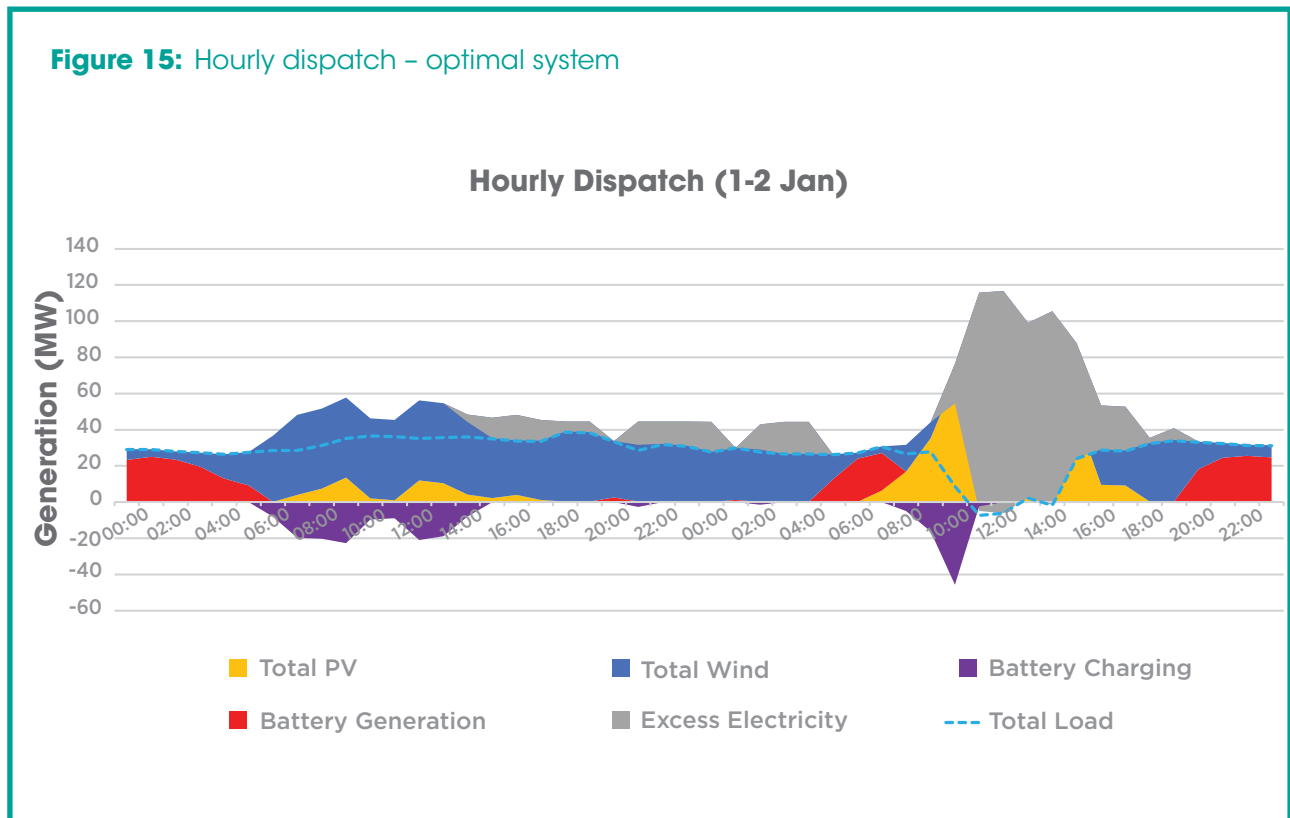

the previous day is used to cover most of the demand in the early morning hours of 1 January. Stored electricity in the battery system is also used to cover the demand on 2 January from 5 a.m. to 8 a.m. and from 7 p.m. to 11 p.m. (see the red stacked area). During the day of 1 January, the wind turbines generate more electricity than the solar panels and excess electricity is produced. This can be seen by observing the grey stacked area that follows the total load, but in certain hours of the day, when excess electricity is generated, it increases. This gives a clear idea of when and how much excess electricity is generated by the wind turbines and solar panels.

As mentioned earlier, the annual excess electricity produced by such a system was estimated to be 94 GWh/year, which is not significantly high. The reason for this is that the optimal system is bound to generate some curtailment when increasing the renewable energy capacity. The light-blue line shows the total load of the system, which during the 9 a.m. and 3 p.m. hours on 2 January reaches negative values. This is because during that period the battery storage system is being charged. This trend can also be seen by observing the peak in the battery charging, signifying that the batteries are being charged during that time. The largest excess electricity occurs during the 11 a.m. hour on 2 January, with the wind turbines generating as much as 116 MW and the solar panels 95 MW.

4.4 Optimal system plus EVs

After the optimal system scenario, the second scenario modelled in this study includes the deployment of electric vehicles to the optimal system. This scenario was selected to show how the electricity demand would increase and how the LCOE would be affected by the deployment of EVs to the previous scenario. The results of the optimal system plus EVs scenario have shown that by adding the deferrable load (that is, the electrical requirements to support the uptake of 100% EVs by 2040) to the optimal system, the total electricity demand of Antigua and Barbuda increases to 489 GWh/year. More importantly, the renewable energy share increases even further to 93.1%, getting closer to the 100% target. In order to achieve this percentage, however, adding further wind power capacity of 71.4 MW to the planned 17.63 MW will be required. This increase in required renewable energy capacity is explained by the increase in electricity demand from the EVs. Hence, more renewable energy capacity will be needed to cover the load and to charge the EVs.

From the HOMER optimisation, no additional solar PV capacity was estimated. With the increased demand, the storage battery system and converter were sized to be 828 MWh and 116 MW respectively. These values show a

Figure 16: Hourly dispatch – optimal system minus residential demand and rooftop PV generation

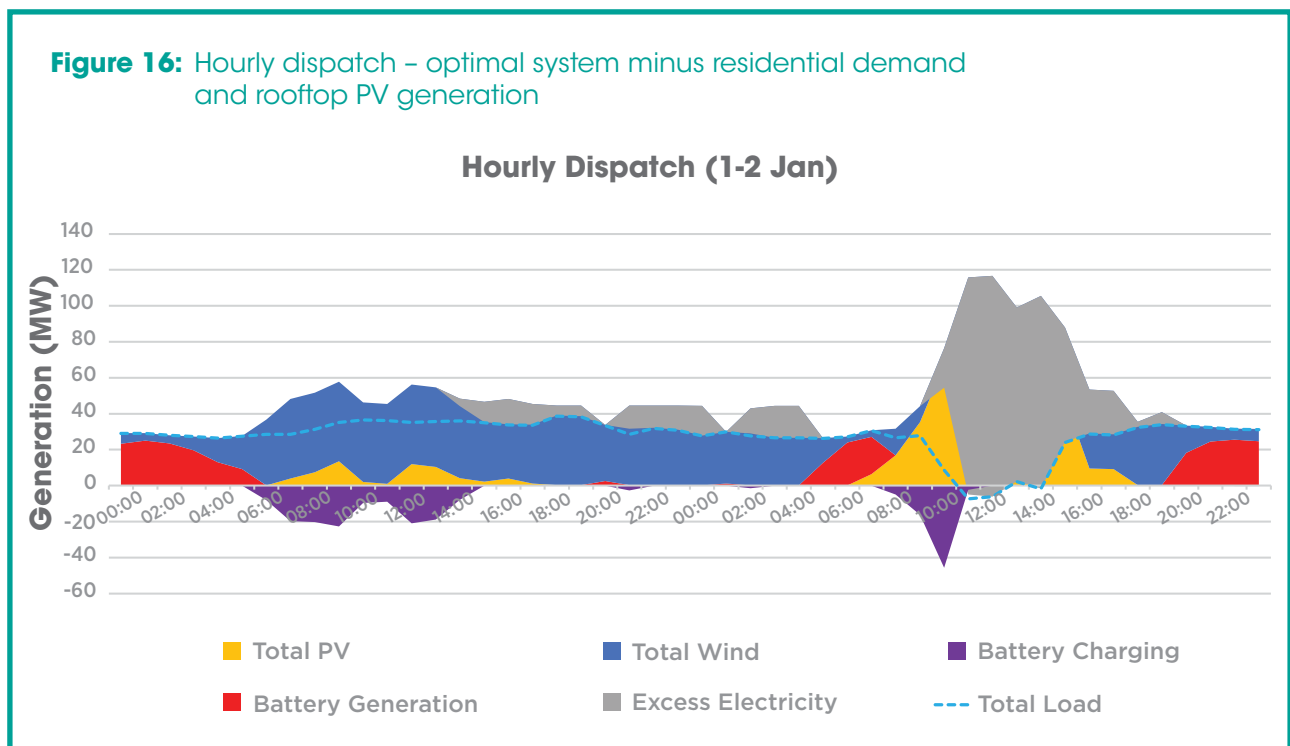

significant increase when compared to the battery and converter of the optimal system. The results have also shown an excess electricity of 100 GWh/year with no unmet electric load and capacity shortage. With respect to the fuel savings, the total heavy fuel oil consumed by the country in this specific scenario would be around 6.2 million litres. This quantity is more than ten times smaller than the current fuel consumption of Antigua and Barbuda. The fuel savings would then translate to almost USD 29.8 million saved annually when compared to the current power system. The average fuel use per day was estimated to be 16 968 litres and the average fuel use per hour to be 707 litres. These values are lower than those optimised in the previous scenario due to the increase in renewable energy capacity.

With regard to the economics of this scenario, the initial capital cost for deploying the system was optimised to be USD 498 million. This is a USD 110 million increase as compared to the optimal system scenario, which can be explained by the larger storage, converter and wind turbine capacity. By adding electric vehicles to the optimal system scenario, the LCOE of the system has decreased from USD 0.105/kWh to USD 0.10/kWh.

The reason that the LCOE has decreased from the previous scenario is due to the increase in renewable energy capacity and storage. The optimal system plus EVs scenario has a net present cost of USD 692 million and an operating cost of USD 13.6 million per year.

As opposed to the optimal system scenario where 8% of the electricity demand was covered by the APC and Blackpine power plants, in this scenario only 5% of the generation comes from heavy fuel oil (see Figure 17). In the previous scenario, a larger share of generation was coming from solar PV, while with the deployment of EVs we see a more even share between solar PV and wind. Almost 50% of the total load of Antigua and Barbuda is being met by the solar arrays, while around 46% is covered by the wind turbines.

Figure 18 shows the installed capacity by technology for the optimal system plus EVs scenario. The doughnut chart shows how the largest installed capacity is solar PV with 199 MW, followed by 91 MW of heavy fuel oil generation. The third technology by capacity is wind, with 89 MW.

Figure 17: Share of generation – optimal system plus EVs

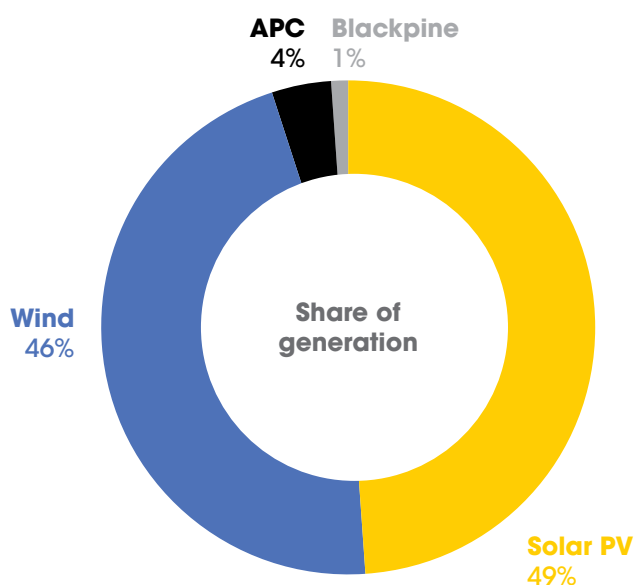
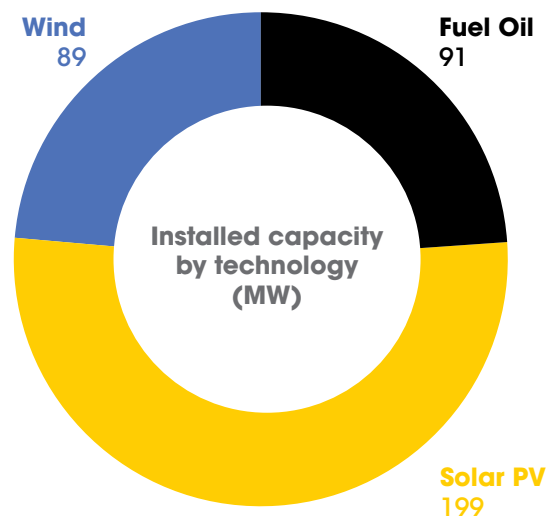

Figure 18: Installed capacity by technology – optimal system plus EVs



A clearer idea of how the optimal system is affected by the deployment of electric vehicles can be made by observing the hourly dispatch curve for 1-2 January in Figure 19. The graph shows the total solar PV output, total wind output, total load, battery generation, battery charging, EV smart charging and excess electricity. The first trend to note from the hourly dispatch curve is that during the early hours of 1 January, most of the load is being covered by the battery storage system (see the red stacked area). This means that the electricity generated by the wind turbines at that particular time of day is not enough to meet the demand. Therefore, stored electricity in the batteries is used to compensate the load. Between 5 a.m. and 5 a.m. of the next day, however, the wind turbines generate enough electricity to cover the entire load as well as producing excess electricity.

On 1 January, the solar PV does not generate as much as the wind turbines, signifying a cloudy day where not much sunlight was available. On 2 January, a large peak in excess electricity is observed between 7 a.m. and 5 p.m. During the later hours of the day, however, a similar pattern is seen as in the early hours of 1 January, with the battery system covering the load. The battery charging stacked area (purple), shows how the battery charges during the early morning hours as soon as there is some excess electricity generated by renewables. The EV smart charging stacked area (dark blue) illustrates how the EVs charge during the morning using the electricity coming from solar PV and wind.

4.5 100% RE (no hydrogen)

The first option considered in this roadmap for Antigua and Barbuda to achieve 100% of its generation from solely renewables was the 100% RE (no hydrogen) scenario. This scenario was considered to show that it is possible to achieve the target set by the Government without adding green hydrogen production and by increasing the solar PV, wind and battery storage capacity. The results of the HOMER modelling showed that by adding further PV capacity of 173 MW to the previously estimated 199 MW, and by deploying further wind turbine capacity of 93 MW, the renewable energy share can increase to 100%. However, it must be noted that a large battery capacity would be needed to achieve this share, and the optimisation results have estimated that a 1.4 GWh battery storage system would be required.

Together with the battery, a converter capacity of 196 MW was also optimised. With the total electricity demand of 375 GWh, the excess electricity has increased significantly compared to the previous scenarios analysed, with 500 GWh/year. This is because the renewable energy capacity has also been increased markedly. Similar to the previous scenarios, no unmet electric load or capacity shortage was present. This scenario analysed a 100% renewable energy power system, hence no heavy fuel oil generation is present.

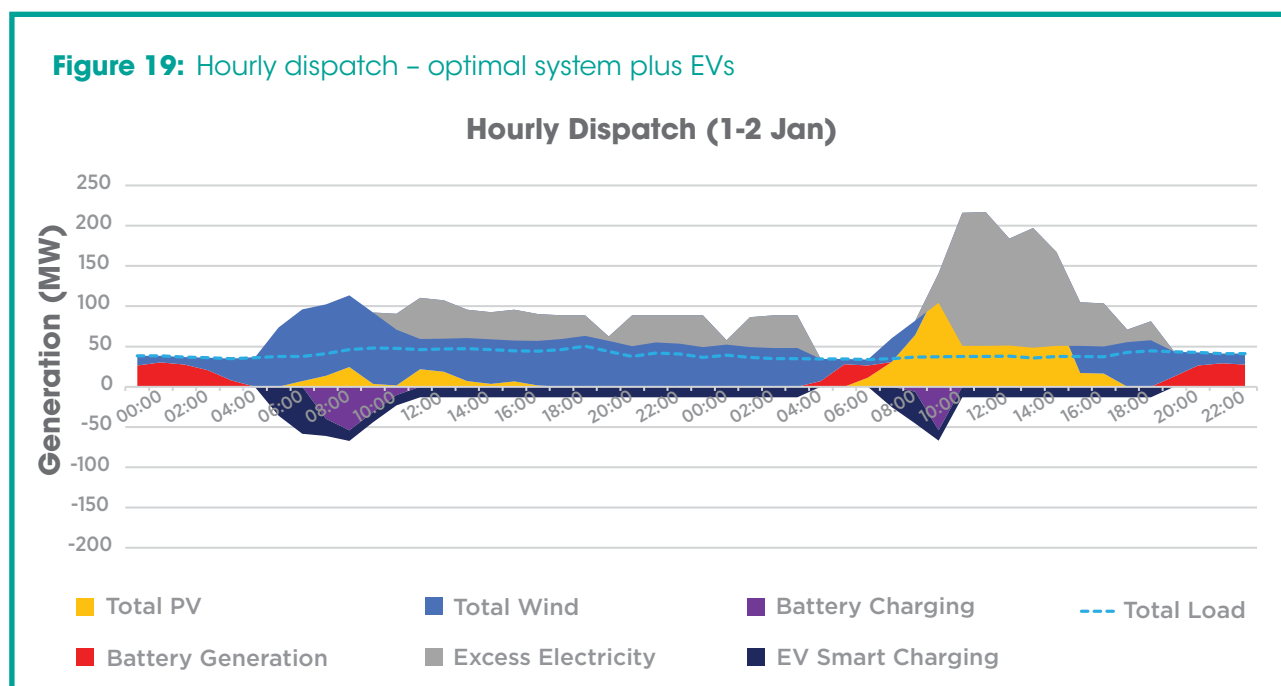

When observing the cost results of the optimisation, it is clear that this scenario has the highest costs when compared to the other scenarios considered in this study. The initial capital cost needed to deploy the above-mentioned renewable energy systems would be around USD 783 million. The LCOE has also increased as opposed to previous scenarios, to USD 0.184/kWh. The net present cost and operating cost for this specific scenario were optimised to be USD 985 million and USD 14.2 million/year respectively. The reasoning behind such high costs is the large battery storage system of 1.4 GWh. Having such a large capacity storage leads to very high capital, replacement and O&M costs.

Figure 20 shows the share of generation for the main components of this scenario. The total electricity load is entirely covered by renewables. Around 61% of the electricity demand is met by solar PV, and the remaining 39% is met by wind. From the figure, it is also clear that the HOMER optimisation has estimated solar energy to be the more dominant source of electricity in Antigua and Barbuda to serve most of the load.

The dominance of solar PV in meeting most of the total load in this scenario is clearer when observing the

installed capacity by technology in Figure 21. Together with the current solar capacity of 9 MW, this scenario also considered 90 MW of residential rooftop PV (based on information provided from the Government of Antigua and Barbuda), 100 MW of ground-mounted PV based on land availability and an additional 173 MW of extra PV that was optimised using HOMER. The total installed solar PV capacity was therefore estimated to be around 372 MW. With regard to wind power capacity, the scenario considered the current 4.13 MW together with 13.5 MW of planned wind capacity and an additional 93 MW that was optimised in HOMER. The total installed wind capacity was thus estimated to be around 111 MW.

The hourly dispatch graph for 1-2 January can be seen in Figure 22. The significant increase in excess electricity discussed earlier is evident when observing the graph. The wind turbines generate electricity throughout the whole day, while the solar panels only generate during the day and when sunlight is available. On 1 January, curtailment occurs only with electricity generated from the wind turbines, which exceeds the total load from 5 a.m. to 5 a.m. of the next day. The solar panels only generate electricity from 6 a.m. to 10 a.m. and from 11 a.m. to 4 p.m., and never exceed the total demand.

Figure 20: Share of generation
- 100% RE (no hydrogen)

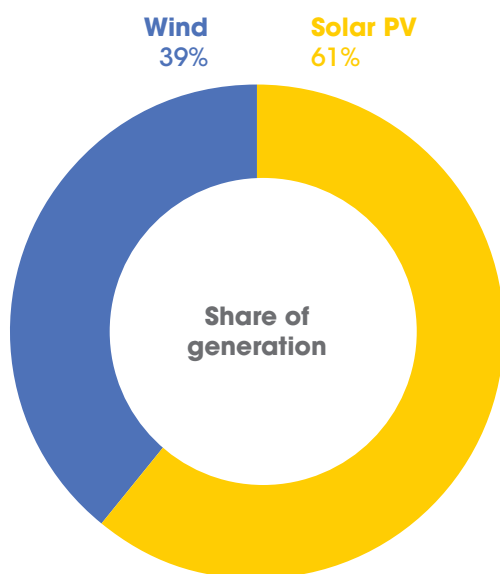

Figure 21: Installed capacity by technology
- 100% RE (no hydrogen)

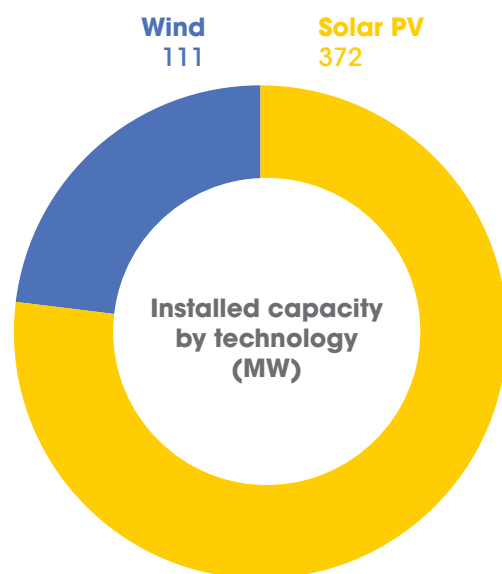
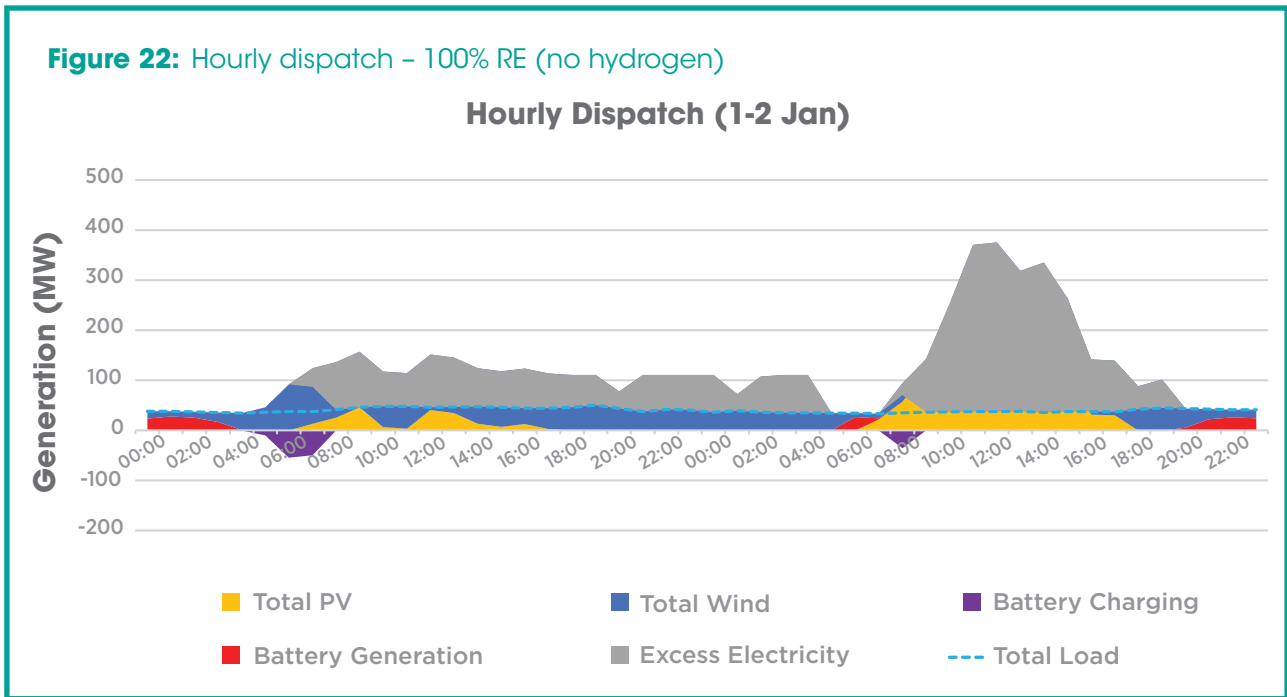

Figure 22: Hourly dispatch – 100% RE (no hydrogen)



In the early morning hours when electricity generated from renewables is not enough to cover the total load, the remaining demand is covered by the battery storage system with stored electricity from the previous day (see the red stacked area).

On 2 January, a very large peak of generation from solar and wind is noticeable from 7 a.m. to 5 p.m. Throughout this period, the demand is totally covered by renewables, and on top of this there is large quantity of excess electricity, some of which is stored in the batteries. During night-time hours when the wind turbines are not generating enough electricity to cover the total load, the batteries meet the demand.

4.6 100% RE (with hydrogen)

In order to achieve a 100% renewable energy share by 2030, the Government of Antigua and Barbuda would need to decommission all the current power plants running on fossil fuels and deploy only renewable energy. This scenario considered the production of green hydrogen from renewables to help achieve the goal set by the Government. The results of the optimisation showed that by doing so, the renewable share will indeed reach the 100% target set by the Government. However, to reach this target, the Government would need to install an extra 3 MW of solar PV capacity on top of the

current plans for the 100 MW of ground-mounted PV and the 90 MW of rooftop PV. Therefore, a total of 202 MW of solar PV would be needed. Furthermore, an additional wind power capacity of 83 MW would be needed to meet the new electrical demand. Through HOMER, it has been evaluated that if this 83 MW of wind power cannot be deployed, then an additional solar PV capacity of 514 MW would be needed instead.

The hydrogen tank was optimised to 500 000 kilograms or 12 000 cubic metres at 700 bar, while the electrolyser and fuel cell were optimised to 75 MW and 40 MW respectively. The battery system was optimised to 164 MWh and the converter to 100 MW. Note that by adding hydrogen, the electrical demand will increase significantly to around 620 GWh/year. Around one-third of the whole electricity demand is due to the hydrogen production, while only 11.5% of the generation is from hydrogen. The optimisation also showed excess electricity of 103 GWh/year. In terms of fuel consumption, the optimisation has estimated around 4 298 tonnes of hydrogen. The average fuel use per day and the average fuel use per hour have been estimated to be 11 777 kilograms and 491 kilograms respectively.

The initial capital cost for such a scenario would be around USD 403 million with an LCOE of USD 0.104/kWh. The initial capital cost is less than half of the initial capital cost for the 100% renewable energy scenario without

hydrogen. On the other hand, the LCOE is the same as the LCOE for the optimal system. This means that with the same levelised cost of electricity, Antigua and Barbuda can achieve a 100% renewable energy share. The 100% renewable energy with hydrogen scenario has a net present cost of USD 548 million and an operating cost of USD 10.3 million/year.

The share of generation for this scenario can be seen in Figure 23. As opposed to previous scenarios, in this specific scenario the wind turbines have the highest share of generation with 44%. Solar PV covers 41% of the demand, and the remaining load is met by the hydrogen fuel cell.

Figure 24 illustrates the installed capacity by technology for this scenario. Solar PV has the largest installed capacity with 202 MW, followed by wind with 101 MW and the hydrogen fuel cell with 40 MW.

The hourly dispatch graph for 1-2 January can be seen in Figure 25. As opposed to previous scenarios, the figure also shows the electrolyser output (orange). In the early morning hours, the electricity generated from renewables is not enough to meet the total load, hence

the batteries meet the remaining demand using the stored electricity (see the red stacked area). The wind turbines generate electricity more or less throughout the whole day, while the solar panels only generate electricity during the hours when sunlight is available. Between 4 a.m. of 1 January and 4 a.m. of 2 January, all of the total demand is met by renewables, with some curtailment occurring during early morning hours.

When observing the electrolyser output, it can be noted that this output is consistent with renewable electricity generation. When the solar PV and wind turbines start to generate electricity, the electrolyser also starts to produce green hydrogen. On 2 January, there is a peak electricity generation from both the wind turbines and the solar PV systems, resulting in excess electricity between 9 a.m. and 5 p.m. Similar to the previous day, the electrolyser produces green hydrogen as the renewable energy technologies start to generate electricity.

Box 1 encompasses in more detail the optimal scenario versus the 100% renewable energy with hydrogen scenario, explaining the differences and how green hydrogen production for Antigua and Barbuda can be cost-efficient and beneficial.

Figure 23: Share of generation – 100% RE (with hydrogen)

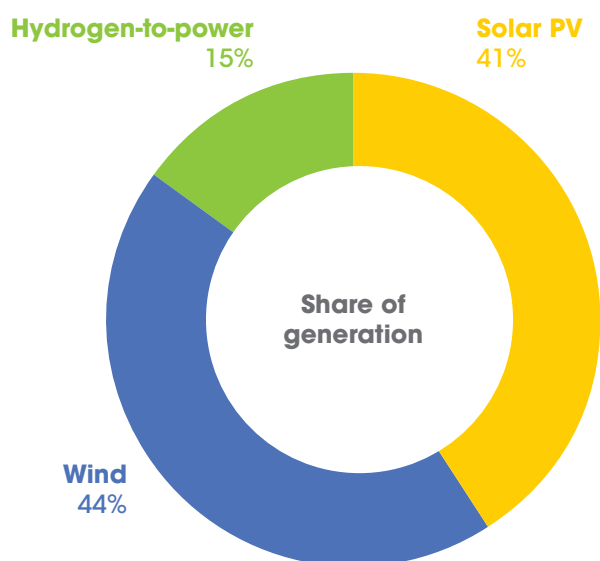

Figure 24: Installed capacity by technology – 100% RE (with hydrogen)

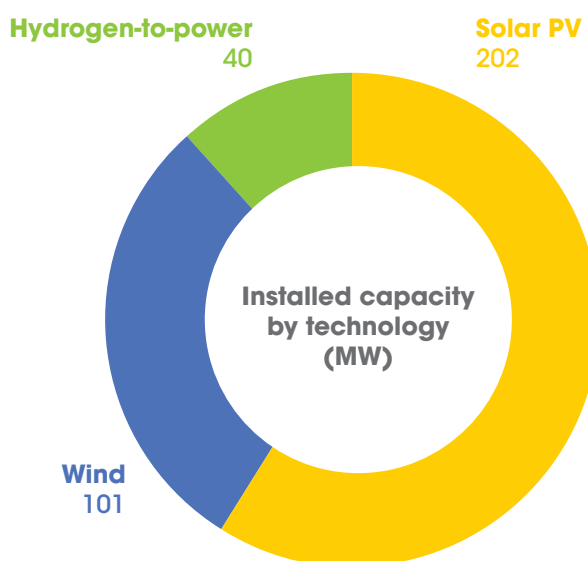
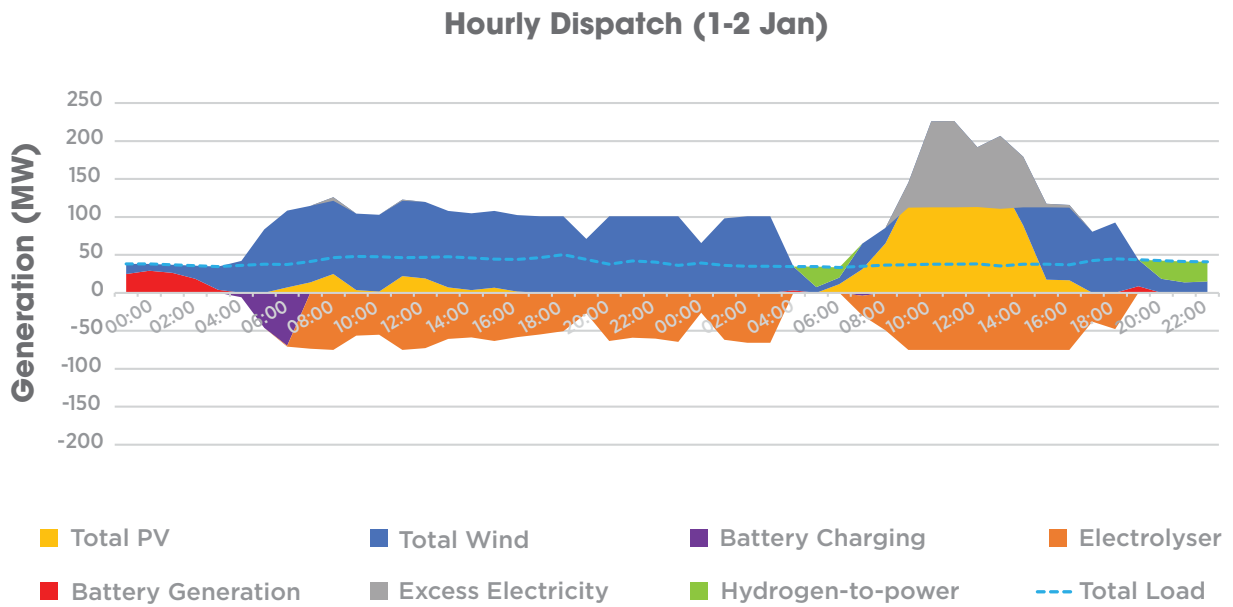

Figure 25: Hourly dispatch - 100% RE (with hydrogen)



BOX 1: HOW GREEN HYDROGEN PRODUCTION CONTRIBUTES TO ACHIEVING A 100% RENEWABLE ENERGY SHARE

The results of the HOMER optimisation have shown that green hydrogen production can aid in cost-effectively achieving the last mile towards a 100% renewable energy share. The Government of Antigua and Barbuda can reach a nearly 90% renewable energy share by deploying more renewable energy, as analysed in the optimal system scenario. However, to reach the final 10% for a fully renewable power system, the Government should explore green hydrogen production. By doing so, Antigua and Barbuda will not only achieve the set target but will also have a more cost-efficient system. With an LCOE of USD 0.104/kWh, the system is slightly cheaper than the one observed in the optimal scenario.

To model hydrogen production from renewables in HOMER, several key assumptions had to be made for the main components. These assumptions include a capital cost of USD 450/kW for the electrolyser, together with a replacement cost of USD 250/kW/year and an O&M cost of USD 25/kW/year. The lifetime was

assumed to be 15 years. For every 1 000 kilograms, the capital cost of the hydrogen tank was assumed to be USD 100 (IRENA, 2019a), while the replacement and O&M costs were assumed to be USD 100/year and USD 1/year respectively. The hydrogen tank was assumed to have a total lifetime of around 25 years. With a capital cost of USD 600, a replacement cost of USD 400 and an O&M cost of USD 0.01/kW/hour of operation, the fuel cell was inputted to have a lifetime of around 50 000 hours. For the optimisation of green hydrogen, a nominal discount rate of 7% with a real discount rate of 5% was assumed.

For a better understanding on how green hydrogen production for Antigua and Barbuda results in a lower LCOE than the optimal power system with diesel generation, the differences in net present cost for each component should be analysed. Figure 26 shows the total net present cost by component for the optimal system scenario considered in this study.

Figure 26: Net present costs by component – optimal scenario

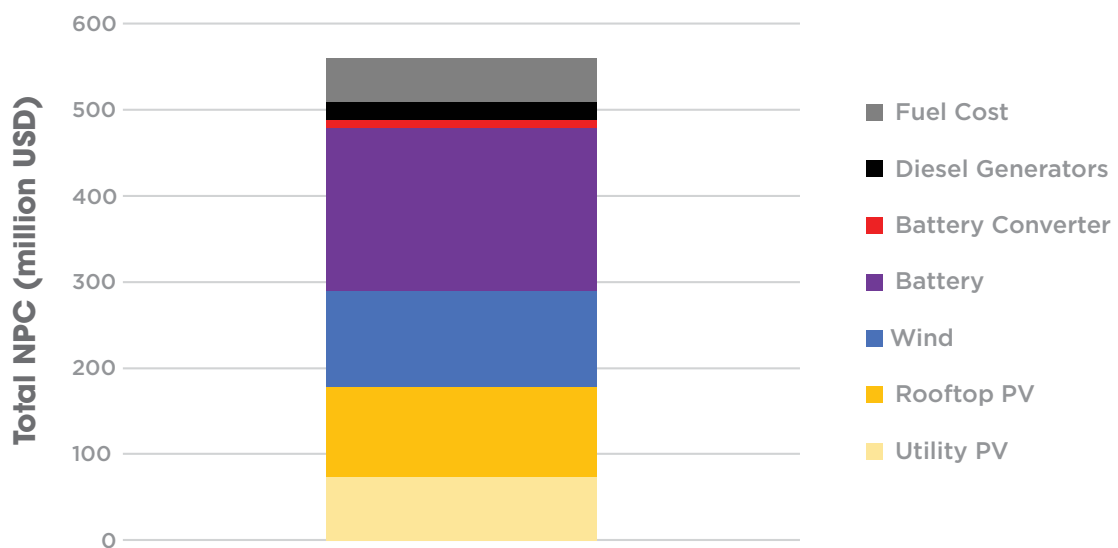

The optimisation results have shown that the battery storage system has the largest net present cost at USD 190 million, followed by wind at USD 112 million, rooftop PV at USD 103 million and utility-scale PV at USD 75 million. The diesel generators, fuel and battery converter have net present costs of USD 20 million, USD 51 million and USD 9 million respectively. Overall, the optimal system scenario has a total net present cost of USD 560 million.

When observing the net present cost by component for the 100% renewable energy (with hydrogen) scenario illustrated in Figure 27, it can be noted that the largest net present cost is for the wind turbines at USD 196 million. The second highest net present cost is for the rooftop PV at USD 103 million, followed by utility-scale PV at USD 77 million, the electrolyser at USD 67 million, the fuel cell at USD 50 million and the battery at USD 41 million. The battery converter and hydrogen tank have net present costs of USD 15 million and USD 57 000 respectively. The total net present cost of the 100% renewable energy (with hydrogen) system as a whole is USD 548 million.

When comparing the net present costs of the diesel generation components and batteries for the optimal scenario with the hydrogen components (electrolyser,

fuel cell and hydrogen tank) for the 100% renewable energy (with hydrogen) scenario, it is evident that the hydrogen components have an overall lower net present cost than the diesel generation components and the large battery system. This enables more renewable energy to replace the remaining 10% of fossil fuels and greatly reduces the need for batteries by producing hydrogen with excess wind, and subsequently using this green hydrogen to produce power when both solar and wind are not available, and the batteries are empty.

Such a difference in cost is also visible when comparing the annualised costs for the two systems, with the optimal system as a whole costing USD 39.4 million/year and the 100% renewable energy (with hydrogen) system costing USD 38.9 million/year. In order to calculate the LCOE, HOMER divides the total annualised cost of the system by the total electricity load served. With a lower annualised cost, the 100% renewable energy scenario (with hydrogen) scenario results in a lower LCOE than the optimal scenario.

Therefore, the optimisation results have shown that not only can Antigua and Barbuda reach the target of a 100% renewable energy share with green hydrogen production, but it can do so in a cost-efficient manner.

Figure 27: Net present costs by component – 100% RE (with hydrogen) scenario

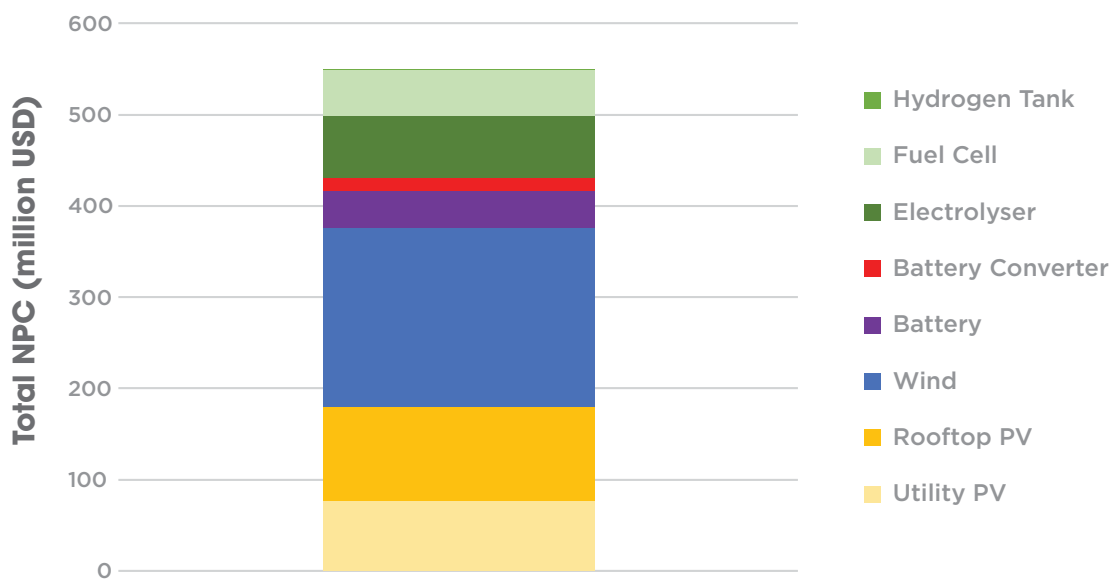

4.7 100% RE (with hydrogen plus EVs)

The last scenario that was modelled in HOMER was the 100% renewable energy with hydrogen plus EVs scenario. This scenario consisted of the 100% renewable energy (with hydrogen) scenario, but in addition it also explored the possibility of replacing all vehicles with EVs by 2040. Hence, together with the electricity demand a deferrable load was also added. The deferrable load in HOMER had a scaled annual average of 310 650 kWh/day, a storage capacity of 770 700 kWh and a peak load of 61 020 kW. The EV load, together with the hydrogen production, increased the total electrical load to 722 GWh/year. This scenario also showed the lowest excess electricity with 62 GWh/year and a capacity shortage of 3.5 MWh/year. No unmet electric load was calculated.

By adding the deferrable load, the total optimised solar PV capacity increased to 214 MW, and the total wind capacity needed increased to 117 MW. This concurrently increased the storage nominal capacity to 138 MWh and the converter to 100 MW. Similar to the previous scenario, the hydrogen tank was optimised to 500 000 kilograms or 12 000 cubic metres at 700 bar and the fuel cell was optimised to 40 MW. The electrolyser, on the other hand, with the increased electricity demand due to the deferrable load, was optimised to 100 MW. In terms of fuel consumption,

the total hydrogen consumed was 4 082 tonnes, with average fuel use per day of 11 186 kilograms and average fuel use per hour of 466 kilograms.

The cost analysis has confirmed that the scenario with a 100% renewable energy share including green hydrogen production and EVs will result as the cheapest option in terms of LCOE. With the cost reductions in renewable energy technologies and by increasing the renewable energy deployment, the LCOE was optimised to be USD 0.09/kWh. The initial capital cost for such a scenario was estimated to be USD 440 million, while the net present cost and operating cost were estimated to be around USD 603 million and USD 11.5 million/year respectively.

Figure 28 shows the total share of generation for the 100% renewable energy scenario including hydrogen and EVs. The largest share of generation is coming from the wind turbines, covering 47% of the total load. The remaining electricity demand is met by solar PV with 40% and the hydrogen fuel cell with 13%.

The doughnut chart with the total installed capacity by technology can be seen in Figure 29. The chart shows that solar PV is the largest installed capacity with 214 MW, followed by wind with 117 MW and then hydrogen with 40 MW.

Figure 28: Share of generation – 100% RE (with hydrogen plus EVs)

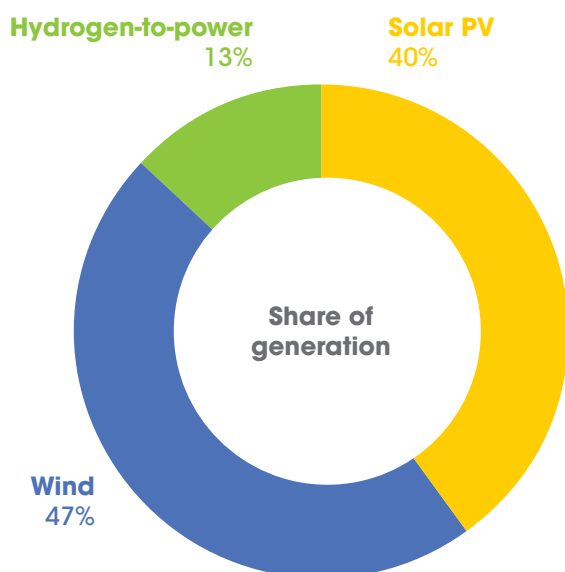

Figure 29: Installed capacity by technology – 100% RE (with hydrogen plus EVs)

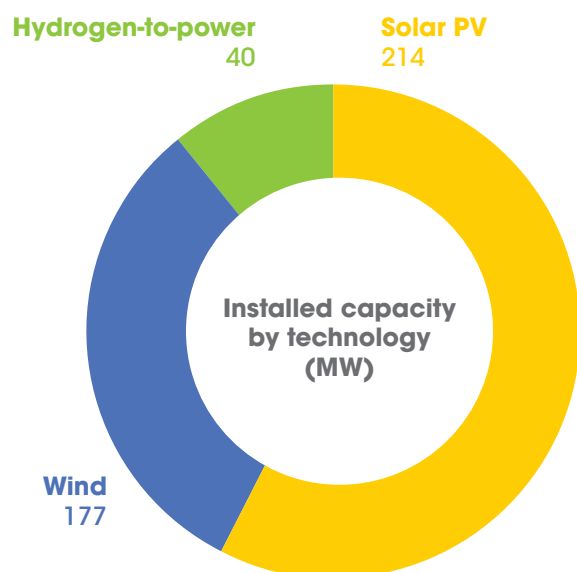

Figure 30: Hourly dispatch – 100% RE (with hydrogen plus EVs)

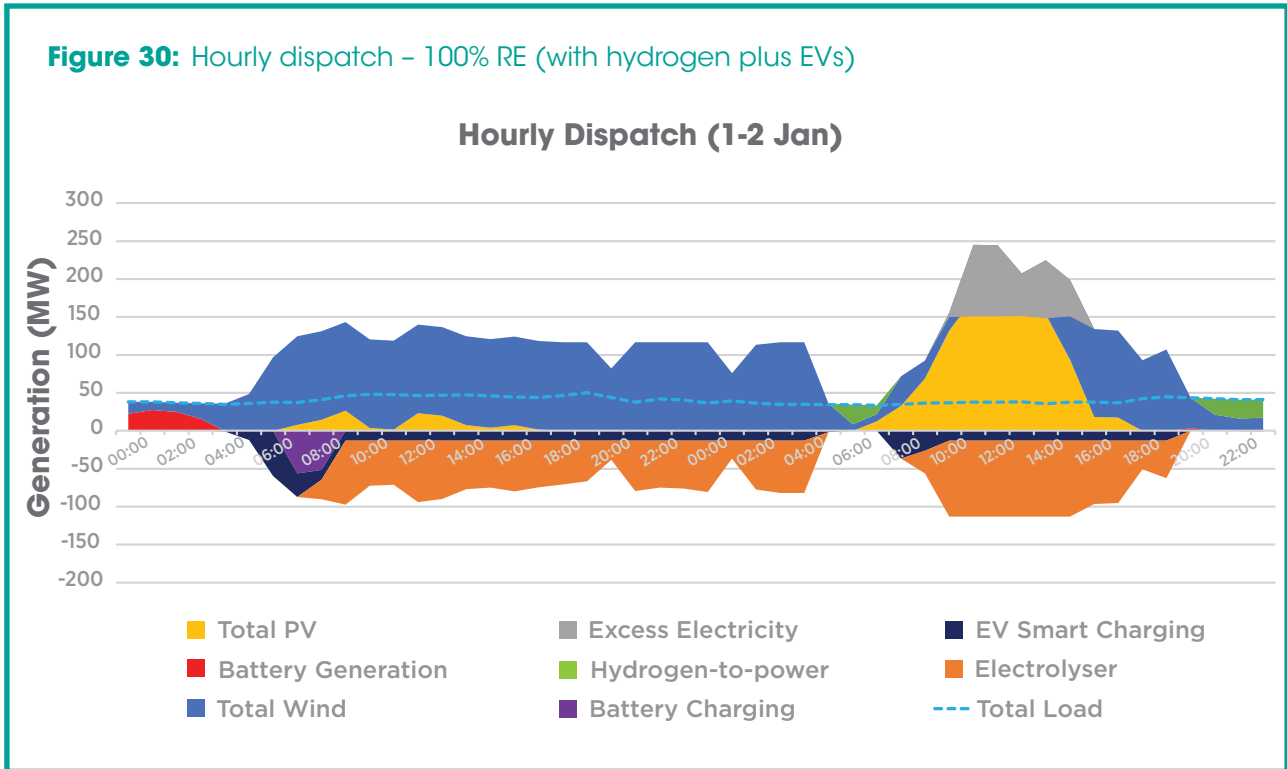

Figure 30 illustrates the hourly dispatch graph for the main components of the system during 1-2 January. The total load (light-blue line) includes also the EV deferrable load. During the early morning hours of 1 January, most of the total load is covered from stored electricity in the battery storage system. Around 4 a.m., however, renewables (mainly wind), commence to cover the entire electricity demand. Between 6 a.m. and 9 a.m., some excess electricity is generated by the wind turbines, after which the total load is covered with renewables until 5 a.m. the next day.

On 2 January, the solar PV panels generate more output than the previous day, also resulting in excess electricity. Similar to the previous day, wind power output is higher than solar and also results in some curtailment from 10 a.m. to 4 p.m. Excess electricity in the figure is represented by the grey stacked area which includes

the total load. Notably, the only time that there is some excess electricity is between 9 a.m. and 4 p.m. on 2 January. During this time, curtailment occurs with the solar PV and wind turbines.

As mentioned earlier, this scenario has shown the lowest annual excess electricity production at 62 GWh. The small amount of curtailment during the day can clearly be seen in the graph. By observing the electrolyser output (orange stacked area), it can be noted that for both days, when solar PV and wind begin to generate electricity, the output of the electrolyser also begins to increase. This indicates that the electrolyser is producing hydrogen using the electricity generated from the renewables. The dark-blue stacked area represents the EV smart charging and shows how the electric vehicles begin to charge during the early morning hours as soon as the renewables begin to generate electricity.

5. BARBUDA

This chapter provides an overview on Barbuda and the analysis performed for the island's power system. It also encompasses the results obtained by the HOMER optimisation, which was based on the design suggested in the Green Barbuda Study conducted in 2018. The optimisation performed for Barbuda also consists of additional solar PV and battery storage capacity, which has been explored to achieve the target set by the Government of Antigua and Barbuda.

5.1 Background

Located north of Antigua, Barbuda has a surface area of 160.6 square kilometres, with an approximate population of 700 people (post-Hurricane Irma). The majority of the population lives in the town of Codrington.

On 6 September 2017, a Category 5 hurricane, known as Hurricane Irma, hit the island of Barbuda. The island had already been evacuated; however, the hurricane damaged and destroyed around 95% of the structures and buildings with winds reaching up to 285 kilometres per hour. Prior to the hurricane, Barbuda's power system consisted of solely diesel generation with a capacity of 2.15 MW (1.35 MW running and 0.8 MW back-up). Instantaneous peak demand on Barbuda prior to the hurricane was around 500 kW, with an average daytime load of around 380 kW and an annual demand of 3.3 GWh. The hurricane destroyed the entire power system of Barbuda, including overhead lines, diesel generators and the majority of the power poles of the island. APUA estimated that post-hurricane, the total load would reach an annual instantaneous peak of 330 kW with 250 kW during daytime.

The Green Barbuda Study was prepared by Masdar through the United Arab Emirates – Caribbean Renewable Energy Fund. The study analysed a new power station for Barbuda, consisting of three main power supply components: diesel generation, a solar PV plant and a battery energy storage system with grid-forming inverters.

The main objectives of the system analysed in the Green Barbuda study by Masdar included serving the load on a 24-hour basis, minimising diesel fuel through solar PV and batteries, and granting priority dispatch for solar PV over energy stored in the battery storage system. The ultimate aim of the design was to maximise the annual renewable energy share.

The proposed system by Masdar consists of the following:

- Around 719 kW peak of solar PV panels along with string inverters;
- 2 diesel generators (two gensets of 330 kW peak output each, for a total of 660 kW);
- 862 kWh lithium-ion battery storage system with grid-forming bi-directional inverter(s);
- Hybrid grid controller.

Considering a 25-year lifetime of the project, the results of the Green Barbuda Study showed an LCOE of USD 0.48/kWh with a renewable energy share of 50.2%. Table 11 provides an overview of the main results obtained by the Green Barbuda Study.

Table 11: Green Barbuda Study – results overview

DESCRIPTION	VALUE
Solar PV capacity (kW)	719
Diesel generator capacity (kW)	660
Battery storage system capacity (kWh)	862
Cost of energy (USD/kWh)	0.48
Renewable energy share (%)	50.2

Although the share of renewables estimated by Masdar is significant, it is still far from the Government’s proposed 100% target. Hence, the roadmap looked into the possibility of adding further renewable energy and battery capacity to increase the share of renewables. In order to model Barbuda’s power system into HOMER, the system designed by Masdar in the Green Barbuda Study was used as a baseline to build the final model. Further optimisation was performed for the solar PV and battery storage system to achieve even further renewable energy capacity. Cost assumptions were based on the assumptions made for the Antigua analysis. The results of the Barbuda model are discussed in the following section.

5.2 Results

Together with the analysis for Antigua, the roadmap also looked into the possibility of transitioning Barbuda’s power system to 100% renewable energy by 2030. In order to do so, the electrical load provided in the Green Barbuda Study was inputted into HOMER to provide the baseline load to build the model. The hybrid system suggested in the Green Barbuda Study was developed in HOMER in addition to further solar PV and battery storage capacity that were optimised. Table 12 shows the overall results obtained from the HOMER optimisation for Barbuda’s optimal system scenario.

The results have shown that by adding a further 1.35 MW of solar PV to the previous 719 kW and a total battery storage system of 4.6 MWh, Barbuda can achieve a nearly 95% renewable energy share. This would be a significant increase in the renewable share, shifting Barbuda’s power system in proximity to the Government’s target. To achieve the final 5% renewable energy share, the Government could look into the possibility of replacing the diesel fuel of the generators with biodiesel.

The optimal system analysed in this study for Barbuda includes solely solar PV with some diesel generation. No EVs or green hydrogen production were explored for the Barbuda analysis. The diesel generators were kept similar to the Green Barbuda Study, with two gensets of 330 kW each. The battery converter was optimised in HOMER to be 451 kW. With a total load of 1.8 GWh, the results have shown excess electricity of 1.39 GWh and no unmet electric load and capacity shortage. In terms of

Table 12: Results of the Barbuda roadmap

MODEL/SCENARIO	OPTIMAL SYSTEM
Electricity demand (GWh/year)	1.8
Excess electricity (GWh/year)	1.39
Rooftop PV (MW)	0
Ground-mounted PV (MW)	2.07
Total PV (MW)	2.07
Total wind (MW)	0
Hydrogen tank (metric tonnes)	0
Electrolyser (MW)	0
Fuel cell (MW)	0
Diesel (kW)	660
Storage (MWh)	4.6
Inverter (MW)	0.451
Renewable energy share (%)	94.9
Cost of energy (USD/kWh)	0.162
Initial capital cost (M USD)	2.82

diesel fuel consumption, the total fuel use was estimated to be 29 043 litres with average fuel use per day of 79.6 litres and per hour of 3.32 litres. As mentioned, the Government of Antigua and Barbuda could explore the possibility of replacing this diesel fuel with biodiesel, making it possible to achieve the 100% target.

With regard to the economics of the optimal system, the results have shown an LCOE of USD 0.16/kWh. This is a clear and significant reduction in the LCOE as compared to the Green Barbuda Study’s USD 0.48/kWh, and can be attributed to the additional solar PV and battery storage capacity optimised by HOMER. Deploying such a system would result in an initial capital cost of USD 2.82 million, with a net present cost and operating cost of USD 4.2 million and USD 95 000/year respectively.

Figure 31: Share of generation – Barbuda optimal system

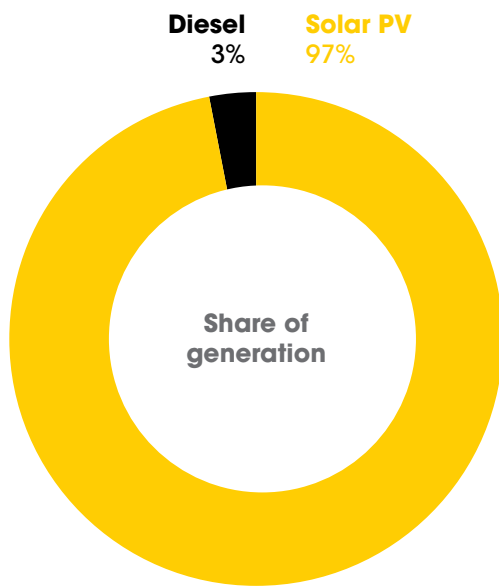

Figure 32: Installed capacity by technology – Barbuda optimal system

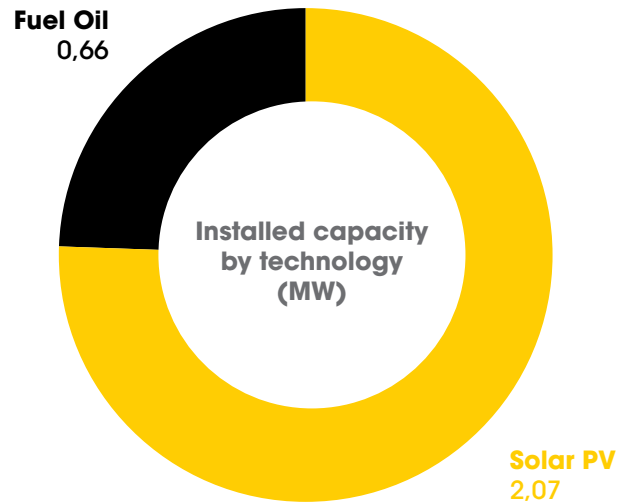

Figure 31 shows the share of generation for the optimal system scenario and the main components. The chart clearly shows the dominance of solar power generation in meeting the total demand of Barbuda. Around 97% (3.27 GWh/year) of the total load would be covered entirely by solar PV, while the remaining 3% (92.5 MWh/year) would be met by the diesel generators.

Figure 32 illustrates the doughnut chart showing the total installed capacity by technology for the optimal system of Barbuda. From the chart, it can be noted that solar PV is the largest installed capacity with a total of 2.07 MW. It is then followed by the diesel generators with 0.66 MW.

To understand better how the various components of the proposed system meet the electricity demand of Barbuda, the hourly dispatch graph for 1-2 January can be observed. Figure 33 illustrates the hourly dispatch for the two days, showing how the load is met every hour by the various components. The figure shows clearly how the solar panels generate electricity during the day, meeting the total demand, and how the batteries use stored electricity during the night time to meet the load when the solar panels stop generating. The

battery generation stacked area (red) shows that stored electricity in the batteries is used during the early hours of the day and during the evening hours of 1 January to meet the total demand. The solar panels generate some excess electricity during the day on 1 January, and this is matched with a peak in the battery charging stacked area. This means that when the panels generate excess electricity, that excess is used to charge the batteries.

Between midnight and 9 a.m. on 2 January, the diesel generators are meeting the total load of Barbuda. However, from 9 a.m. to 5 p.m. on 2 January, a large peak in solar PV generation and excess electricity is noticeable. The peak in solar generation reaches almost 1.8 MW at noon. The reason behind this large peak could be a very sunny day where the solar panels were able to constantly generate electricity. As was the case with the previous day, the peak in excess electricity (grey stacked area) is matched with a peak in battery charging (purple stacked area). This signifies that the batteries are being charged when excess electricity is being generated by the solar system. During the final hours of the day, however, the solar panels stop generating electricity and therefore the stored electricity is used to meet the total demand of Barbuda.

Figure 33: Hourly dispatch – Barbuda optimal system

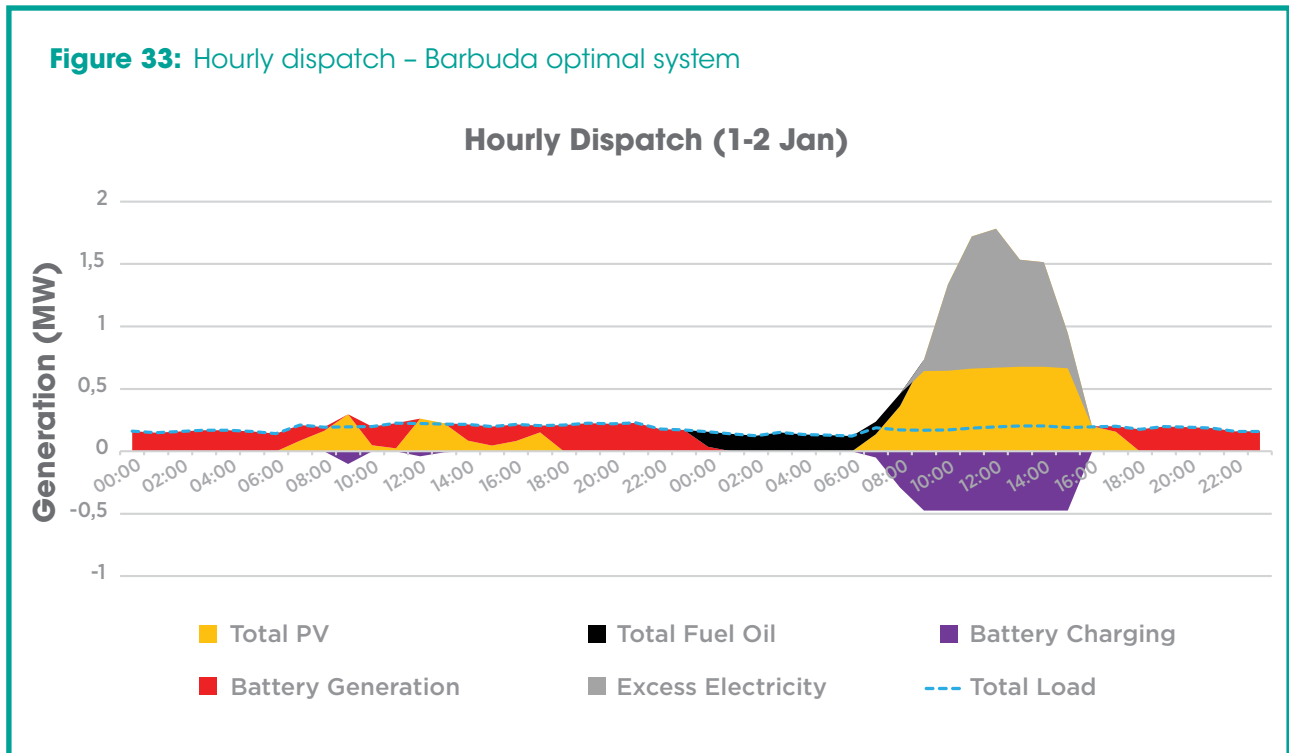

6. POLICY RECOMMENDATIONS AND CONCLUSIONS

The Roadmap for Antigua and Barbuda concludes that increasing the renewable energy share to 100% through a mixture of solar, wind, hydrogen and (if required) biodiesel (for example, for Barbuda) – as identified in the target proposed by the Government for the revision process of the Nationally Determined Contributions – is both technically feasible and economically viable. The optimal system scenario is the recommended path forward to substantially increase the share of renewables for Antigua and Barbuda from the current 3.55% to a potential 90%. The remaining 10% can then be reached by exploring green hydrogen production as analysed in the 100% RE (with hydrogen) scenario. By 2040, full deployment of electric vehicles to further increase the renewable energy share in the transport sector can also be achieved cost-efficiently.

Without putting in place the necessary policies and regulations, however, the implementation of the path identified is unlikely to be achieved. This final chapter covers some recommendations that can be considered for further policy developments, to enable the implementation of the decarbonisation pathways identified in this report.

6.1 Recommendations

This roadmap has identified that accelerated deployment of solar PV and wind is crucial for achieving the proposed target set by the Government of Antigua and Barbuda, where renewables will dominate the energy sector by 2030, with 100% of the power generation coming from these resources. Additionally, green hydrogen production will be essential to achieve a fully decarbonised system.

The study has also shown that electricity storage will contribute to increasing the benefits from solar PV and wind.

As mentioned, the optimal system scenario explored in this roadmap is the recommended option for the Government of Antigua and Barbuda. The results of the techno-economic modelling of the power and transport sectors have revealed that a significant increase in renewable energy share can be achieved through such a system. In terms of associated costs and initial investment, the Government would require an initial upfront investment of around USD 388 million. However, when deploying electric vehicles together with the optimal system, the initial capital cost will increase to USD 498 million due to the additional storage required. The recommended option will also result in substantial fuel savings when compared to the current power system, with USD 29.3 million saved. Furthermore, a clear reduction in the LCOE will also occur, with an estimate of USD 0.105/kWh.

This section outlines several policy recommendations to enhance the renewable energy resources that can help Antigua and Barbuda pursue the path outlined in this roadmap.

Follow international best practices for procurement

To decrease the costs and accelerate renewable energy deployment in Antigua and Barbuda, a key recommendation for the Government is to follow international best practices for procurement of the

proposed renewable systems. By doing so, the project will become more attractive to international players (for example, suppliers, EPC companies and developers), and subsequently this is expected to bring down the overall costs by increasing competition. Notably, a well-developed market for renewable energy systems is not currently present in Antigua and Barbuda, and this is necessary to bring down the costs.

Another way to decrease the costs for installation and operation and maintenance (O&M) to the minimum is to support the development of the local private sector, by supporting access to capacity building and vocational trainings. Partnerships between international suppliers and local companies for the installation and maintenance of renewable systems is key to bring down

the costs. Furthermore, this will create benefits for the local economy by creating jobs, specifically for O&M and installation. It is important to consider that the manufacturing of the components of these systems will not be local, but the installation and O&M is typically done with local companies, subject to the necessary training of staff.

A successful example of islands procuring large capacities of solar PV with battery storage to implement a strategic policy to achieve 100% renewable energy, while reducing electricity cost, is the case of the US state of Hawaii. This is detailed in Box 2, showcasing the various regulations and steps put into place by the state in increasing its renewable energy capacity and decreasing costs.

BOX 2: SUCCESSFUL PROCUREMENT OF SOLAR PV AND STORAGE IN ISLANDS – THE HAWAII EXAMPLE

The US state of Hawaii has set an ambitious target to achieve a 100% renewable energy share by 2045, as outlined in the 2016 Power Supply Improvement Plan of the local utility, Hawaiian Electric. The state has outlined a detailed plan charting the way forward to accelerate the achievement of this target (Hawaii State Energy Office, 2021). The Hawaii State Energy Office has set the following Renewable Portfolio Standard (RPS) incremental targets in order to achieve the final 100% target by 2045:

1. 30% RE share by 2020
2. 40% RE share by 2030
3. 70% RE share by 2040
4. 100% RE share by 2045.

Together with the above targets, the State of Hawaii is continuing in aligning government policies and regulations with clean energy goals; deploying renewable generation and appropriate grid infrastructure; facilitating the processes for deploying renewable energy; and exploring the next generation of existing technologies.

Moreover, Hawaii has put in place a strategy to modernise the grid as a key enabler of clean energy. Having a strong communications system in the electric grid enables it to operate more efficiently and to simultaneously accommodate higher shares of variable renewable energy. Furthermore, it makes it possible to bring down the overall costs with higher efficiency and speed.

Figure 34: Grid modernisation schematic for Hawaii

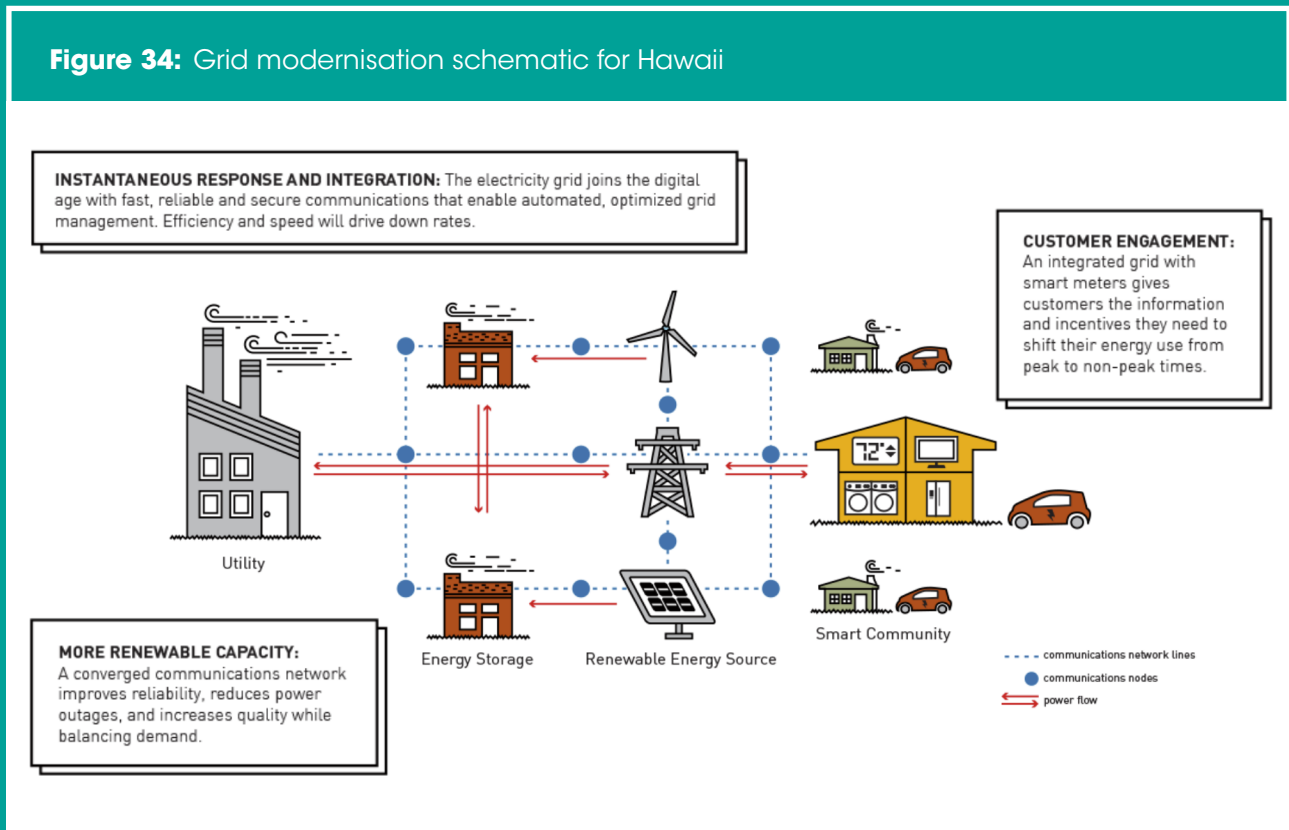

Source: Hawaii.gov

According to the State of Hawaii, modernising the electric grid will encourage private investment and make it possible to take advantage of utility-scale and distributed generation resources. The strategy that has been put into place by Hawaii to modernise the grid involves the following steps:

1. Develop sufficient energy storage capacity and advanced grid upgrades
2. Adopt regulations and standards as recommended by the Hawaii Public Utilities Commission.
3. Balance technical, economic, environmental and cultural considerations
4. Leverage Hawaii’s position to promote innovation for new energy solutions
5. Promote a marketplace that benefits both consumers and producers.

Such a policy has allowed Hawaii to increase its renewable energy share and get closer to the target set of 100% renewable energy by 2045.

Together with a strategy for modernising the grid, the state of Hawaii has implemented an energy policy to maximise the deployment of cost-effective investments in clean energy production. The successful Hawaii state energy policy has the following five directives:

1. Diversify the energy portfolio
2. Modernise and connect the grids

In terms of procurement, Hawaii procures its renewable energy systems through competitive bidding and request for proposals. In January 2019, Hawaiian Electric announced seven new **solar-plus-storage** contracts for a total of 262 MW of solar with 1 048 MWh of storage distributed over three islands. **Prices ranged from USD 0.12/kWh to a record-breaking price of USD 0.08/kWh.** When compared to past

Figure 35: Hawaiian Electric January 2019 Request for Proposals – capacity vs. prices

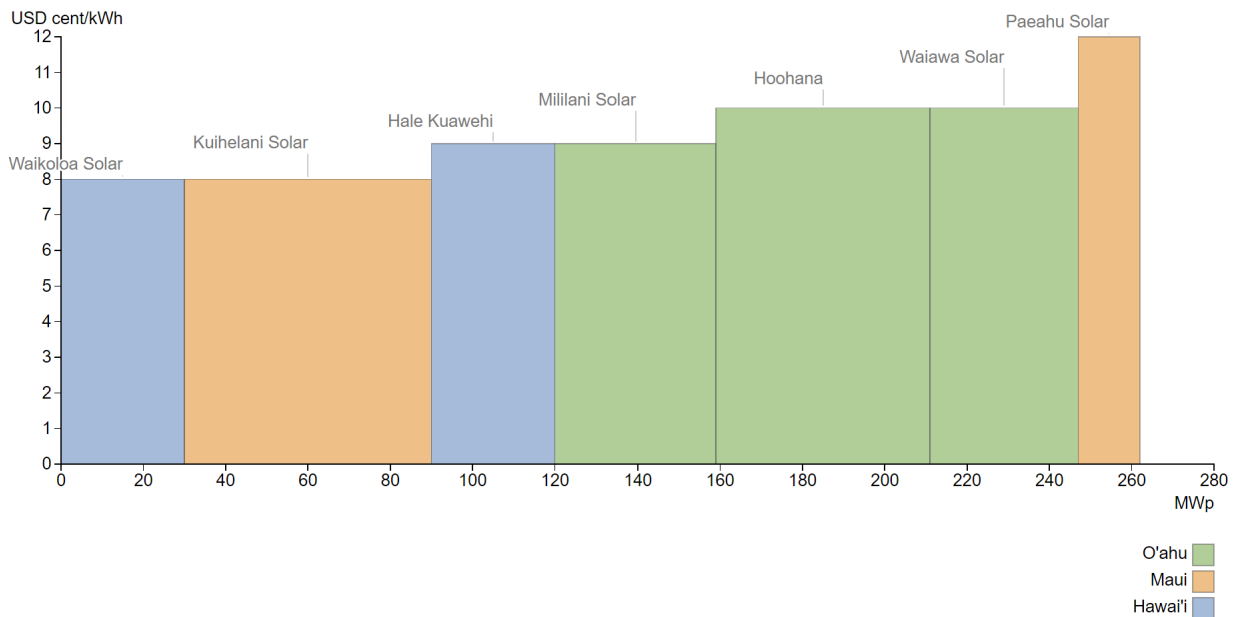

Note: For every MW of solar PV, all projects have 4 MWh of storage

solar-plus-storage prices in Hawaii of USD 0.139/kWh in 2016 and USD 0.11/kWh in 2017, this represents a significant reduction (Greentech Media, 2019).

In August 2019, Hawaiian Electric issued a second large request for proposals for around 900 MW of renewable energy and storage systems. Specifically, the request for proposals included 203 MW of solar for the island of Hawaii, 594 MW for Oahu and 135 MW for Maui. The request for proposals was broken down into different projects and structured in a way to replace two large fossil fuel power plants that are planned to be decommissioned soon.

In May 2020, Hawaiian Electric selected 16 winning projects totalling 460 MW of solar with almost 3 GWh of storage. This was the largest renewables procurement in Hawaii as the state made significant steps towards achieving its 100% renewable energy target by 2045 (Greentech Media, 2020).

The Government of Antigua and Barbuda can learn from the successful example of the state of Hawaii in implementing a targeted and specific policy directive that can help not only in achieving the target of a 100% renewable energy share but also aid in procuring cost-efficient renewable energy systems.

Move forward with a renewable IPP

The study demonstrates the technical and economic feasibility of a high-renewable-share scenario combining variable renewable energy plus battery storage systems with EVs, hydrogen and biodiesel. Furthermore, it has shown the potential benefits of deploying additional renewable energy in Antigua and Barbuda and how the Government can greatly increase the share of renewables cost-effectively. However, the roadmap analysis has also revealed that the current power system of the country is highly dependent on conventional fossil fuel generation, and that substantial renewable energy capacity is needed to achieve the ambitious target.

The largest power plant in the island, APC, is owned and operated by an independent power producer (IPP), and energy is sold to APUA through a power purchase agreement. A key recommendation is for a future power purchase agreement with the IPP to exclusively consider the purchase of renewable electricity rather than generic electricity or electricity based on oil products. This will put Antigua and Barbuda on a pathway shifting from a power system widely dominated by fossil fuel generation towards one with higher shares of renewable energy.

Make residential PV beneficial for the system

Antigua and Barbuda has one of the highest domestic electricity tariffs in the Caribbean region due to volatility in fuel costs and climate change impacts that have caused serious damage to the national electricity grid. The Department of Environment conducted a socio-economic study in 2020, including a national survey of 1100 people in Antigua and Barbuda to evaluate the costs and effects of climatic events on households. The survey found that the average household in the country typically pays around 7-10% of its monthly income on electricity. Furthermore, the survey found that most households supported the deployment of renewable energy technologies, with 62% indicating that they considered renewables beneficial for their homes and 70% stating that lowering their electricity bill was the primary reason that would encourage them to install renewables.

As analysed in the roadmap, the deployment of solar PV and battery systems for the residential sector of Antigua and Barbuda will be an important element, as planned by the Government, for achieving a fully decarbonised

power system by 2030. The analysis shows that the total load for Antigua and Barbuda without the residential load would be around 250 GWh/year. Such a system would have 94 GWh of excess electricity production with no unmet electric load and no capacity shortage.

It must be noted, however, that when 90 MW of residential PV with battery storage systems is deployed for the 30 000 households as per the residential scenario observed in this study, this will impact the rest of the power system. It is essential therefore to sustain the rest of the power system and avoid making residential solar PV problematic for the system as a whole; this would be the case if rooftop PV is mostly fed into the grid when the grid already has abundant utility-scale PV generation, instead of being stored in batteries and used to cover evening residential demand. These challenges can be addressed in several ways, such as by ensuring that technologies complementary to solar PV are installed and by creating incentive tariffs for charging the batteries during peak hours rather than selling electricity to the grid.

When coupled with residential PV, the battery storage system can absorb excess electricity during the day and use it during night time. This is also known as behind-the-meter (BTM) storage because it is located downstream of the connection point between the utility and the customer (IRENA, 2020c). BTM storage can aid consumers in decreasing their electricity bill, through demand-side management. This is done by absorbing electricity when there is excess renewable energy generation or when electricity prices are cheaper and selling the absorbed electricity to the grid when electricity prices are expensive. However, this only works if the consumer can sell back to the grid, which is not always the case. Aggregated BTM storage can provide support for system operation, while also deferring network and peak capacity investment (IRENA, 2019b).

Another suggestion for sustaining the system and making the residential PV beneficial is for the Government of Antigua and Barbuda to design time-of-use tariffs. Such tariffs are designed to incentivise customers to use more electricity at off-peak times. Time-of-use tariffs charge higher rates during peak demand and charge lower rates during certain hours of the day or night when the electricity demand is at its lowest. This enables the customers to adjust their electricity consumption voluntarily in order to balance demand (IRENA, 2019c).

6.2 Conclusions

This renewable energy roadmap charts the way forward for Antigua and Barbuda's energy and transport sectors by 2030 and 2040, respectively. The roadmap looks in detail at the power sector and outlines the path to a resilient, decarbonised, least-cost power system, which can be leveraged to decarbonise road transport through electromobility. Furthermore, renewable energy options for the transport sector are also explored. The analysis has shown that Antigua and Barbuda can cost-effectively achieve the ambitious target proposed by the Government of a 100% renewable energy share by 2030. The current power system is widely dominated by fossil fuel generation, and with the plans in place as of 2020, the renewable share would merely increase to 9%.

To significantly increase its share of renewables, Antigua and Barbuda should follow the pathway of the optimal system scenario outlined in the Roadmap. This would allow the Government to increase its share of renewables to 90% using solar PV, wind and battery storage.

The Roadmap then explored three specific pathways to reach a 100% share of renewable energy, with the most cost-efficient scenario being the one considering green hydrogen as a mean to store some fuel for ensuring system adequacy in a system with 100% solar and wind generation. With full deployment of electric vehicles by 2040, the Roadmap has shown that the levelised cost of electricity will fall even further, due to smart charging replacing the need to invest in battery storage. As a result, the scenario with 100% renewable electricity, green hydrogen and electric vehicles is the most cost-efficient one in terms of the levelised cost of electricity.

In order to achieve the full benefits of this transformation, appropriate policy regulations should be considered. This roadmap has provided several suggestions on possible policies and regulations that the Government of Antigua and Barbuda could implement. The increased deployment of renewable energy technologies, enabled by the appropriate policies and regulations, will not only be beneficial for the environment but will also benefit the local economy by creating jobs.

REFERENCES

- CIA** (2015), The World Factbook: Antigua and Barbuda, US Central Intelligence Agency, Washington, D.C., www.cia.gov/library/publications/the-world-factbook/geos/ac.html.
- Greentech Media** (2020), "Blowing through milestones: Hawaiian Electric picks winners in solar-storage bonanza", www.greentechmedia.com/articles/read/hawaiian-electric-picks-460mw-of-solar-nearly-3gwh-of-storage-to-replace-power-plants.
- Greentech Media** (2019), "Hawaiian Electric announces 'mind-blowing' solar-plus-storage contracts", www.greentechmedia.com/articles/read/hawaiian-electric-industries-announces-mind-blowing-solar-plus-storage-cont.
- Hawaii State Energy Office** (2021), "Grid modernization", <https://energy.hawaii.gov/renewable-energy/grid-modernization>.
- HOMER** (May 2020), "Seasonal profile plot", https://www.homerenergy.com/products/pro/docs/latest/seasonal_profile_plot.html.
- IRENA** (2020a), Renewable power generation costs in 2019, International Renewable Energy Agency, Abu Dhabi.
- IRENA** (2020b), Green hydrogen cost reduction: Scaling up electrolyzers to meet the 1.5°C climate goal, International Renewable Energy Agency, Abu Dhabi.
- IRENA** (2020c), Electricity storage valuation framework: Assessing system value and ensuring project viability, International Renewable Energy Agency, Abu Dhabi.
- IRENA** (2019a), Hydrogen: A renewable energy perspective, International Renewable Energy Agency, Abu Dhabi.
- IRENA** (2019b), Innovation landscape brief: Behind-the-meter batteries, International Renewable Energy Agency, Abu Dhabi.
- IRENA** (2019c), Innovation landscape brief: Time-of-use tariffs, International Renewable Energy Agency, Abu Dhabi.
- IRENA** (2017a), National energy roadmaps for islands, International Renewable Energy Agency, Abu Dhabi.
- IRENA** (2017b), Electricity storage and renewables: Costs and markets to 2030, International Renewable Energy Agency, Abu Dhabi.
- IRENA** (2015), Study on the integration of renewable energy in Antigua, International Renewable Energy Agency, Abu Dhabi.

ANNEX

Table 13 shows the overall results obtained from the HOMER optimisation when analysing the current power system of Antigua and Barbuda.

Table 13: Current power system overall results

MODEL/SCENARIO	CURRENT POWER SYSTEM
Electricity demand (GWh/year)	375
Excess electricity (GWh/year)	0
Rooftop PV (MW)	2
Ground-mounted PV (MW)	7
Total PV (MW)	9
Total wind (MW)	0
Hydrogen tank (metric tonnes)	0
Electrolyser (MW)	0
Fuel cell (MW)	0
Diesel (kW)	(x3) 14 400 (x2) 8 640 (x2) 6 600 (x6) 6 000* (x1) 17 076
Storage (MWh)	0
Inverter (MW)	0
Renewable energy share (%)	3.55
Cost of energy (USD/kWh)	0.15
Initial capital cost (million USD)	-
Net present cost (million USD)	803
Operating cost (million USD/year)	56.4

* Decommissioned on 15 September 2020

In order to achieve more detailed results from the optimisation analysis conducted in this study, land availability was assessed for possible deployment of solar PV systems. The information provided from the Ministry of Health, Wellness and the Environment of Antigua and Barbuda identified two possible locations for the installation of solar PV arrays. The two sites identified by the Government were the Parham Ridge Wind Farm site

(with around 40 hectares) and the land adjacent to the Bethesda array (with around 40 hectares).

Based on the information and land availability mentioned above, a total of 47 MW of solar PV was estimated for the Parham Ridge Wind Farm site (see Figure 36), while a total of 60 MW of solar PV was deduced for possible deployment at the land adjacent to the Bethesda array (see Figure 37).

Figure 36: Estimated space required for PV at Parham Ridge Wind Farm site



Figure 37: Estimated space required for PV adjacent to the Bethesda array



